

Cardiodrive Installation, Operation and Service Manual



710 N. Tucker Blvd
Suite 110
St. Louis, MO 63101
USA
1-314-678-6100

www.stereotaxis.com

© Stereotaxis 2008, 2022

R_x ONLY

CE 2797

Contact Stereotaxis

Stereotaxis, Inc.
710 N. Tucker Blvd
Suite 110
St. Louis, MO 63101
USA
www.stereotaxis.com
1-314-678-6100 (*Stereotaxis — US*)
0031.75.77.133.13 (*Stereotaxis — EU*)
1-314-678-6200 (*TeleRobotic Support Team — US*)



Made In USA

EC Representative

MDSS
(Medical Device Safety Service GmbH)
Schiffgraben 41
30175 Hannover, Germany



UK Representative

MDSS-UK RP LIMITED
6 Wilmslow Road, Rusholme
Manchester M14 5TP
United Kingdom
Tel.: 0044 (0)7898 375115



Importer

MedEnvoy
Prinses Margrietplantsoen
33 - Suite 123,
2595 AM The Hague
Netherlands



Patents

Manufactured under one or more of the following patents:

United States

7,066,924; 7,635,342; 7,766,856

European

EP 1 389 958 (B1)

EP 1 781 364 (A2)

Trademarks

- *Cardiodrive* and *Niobe* are trademarks of Stereotaxis, Inc., registered in the United States, the European Community, and Japan.
- *QuikCAS* is a trademark of Stereotaxis, Inc.

All other brand names, product names, or trademarks are the property of their respective owners.

EMC Directive Statement

EMC Directive Compliance	This equipment was tested and found to conform to the Medical Directive 93/42/EEC for electromagnetic compatibility. Compliance with this Directive is based upon compliance with the following harmonized standards:
Emissions:	IEC 60601-1-2:2004 3rd Ed., EN 60601-1-2:2007, EN55011:2007+A2:2007, EN61000-3-2:2006, EN61000-3-3:1995 +A1:2001 +A2:2005
Immunity:	IEC 60601-1-2:2007, IEC 60601-1-2:2004 3rd Ed. EN61000-4-2:1995 + A1:1999 + A2:2001, EN61000-4-3:2006, EN61000-4-4:2004, EN61000-4-5:2005, EN61000-4-6:2007, EN61000-4-8:1993 + A1:2001, EN61000-4-11:2004

When operating this equipment, verify that other devices installed near it conform to the applicable EMC standards for that device.

Related documents



Published by Stereotaxis, Inc.:

HDW-0312 – *Niobe* ES User Guide



WARNING: No modification of this equipment is allowed. No user-serviceable parts are inside the *Cardiodrive* system. The user should not attempt to disassemble any portion of the *Cardiodrive*.



WARNING: To avoid the risk of electric shock, this equipment must only be connected to a supply mains that have a protective earth ground.

Operating conditions

Temperature: 15°C to 30°C

Humidity: 20% to 75%, non-condensing

Atmospheric pressure: 70 kPa to 106 kPa

Storage and transport conditions

Temperature: –10°C to 50°C

Relative humidity: 20% to 95%

Atmospheric pressure: 70 kPa to 106 kPa

Disposal

This product should be recycled and not disposed of as general waste (subject to WEEE annex IV resp. EN 50419).

Waste and Recycling

A contractor is responsible for the disposal and recycling of scrap metals and electronics found in the *Cardiodrive* system.

Suggested Contractor: Walch Recycling & Edelmentalle



Notice to the User and/or Patient

Any serious incident that has occurred in relation to the device should be reported to the manufacturer and the competent authority of the Member State in which the user and/or patient is established.

Cover art

Cover art © 2017, 2022 Stereotaxis, Inc.

Contents

Introduction	7
About the <i>Cardiodrive</i> system	7
Intended use	7
Companion magnetic navigation system	7
About this user guide	7
Safety	8
Electromagnetic compatibility information	9
Definitions	12
Graphics and Symbols	13
Configuring the <i>Cardiodrive</i> System	15
System components.....	15
System interconnection	16
Installing the Controller (030-002046).....	16
Installing the Motor (030-005115)	17
Installing the Disposable Advancer Unit (001-001751-1)	17
<i>Cardiodrive</i> Instructions for Use.....	17
Powering up <i>Cardiodrive</i> unit.....	17
Powering down <i>Cardiodrive</i> unit.....	17
Performance specifications	18
Additional information	18
<i>Cardiodrive</i> Maintenance	18
Cleaning	18
General safety.....	18
Index.....	19

Figures

Figure 1. *Cardiodrive* Advancer Unit15
Figure 2. *Cardiodrive* interconnect diagram16

Tables

Table 1. Glossary.....12
Table 2. Graphics and symbols13
Table 3. CAS performance specifications18

Introduction

About the *Cardiodrive* system

The Stereotaxis *Cardiodrive* automated catheter advancement system (CAS) is a tool that provides the physician with the ability and the choice to advance and retract catheters from a control room.

Intended use

In the United States and Canada, the following Indications are applicable for the *Cardiodrive* system.

- The Stereotaxis *Cardiodrive* system is intended for automatically advancing and retracting only compatible magnetic electrophysiology (EP) mapping and ablation catheters inside the patient's heart when used in conjunction with a Stereotaxis robotic magnetic navigation system (RMNS).
- The *Cardiodrive* system is not intended to advance the EP mapping and ablation catheters through the coronary vasculature or the coronary sinus.

In all other geographies, the following Indications are applicable for the *Cardiodrive* system.

The Stereotaxis *Cardiodrive* system is intended for automatically advancing and retracting only compatible magnetic electrophysiology (EP) mapping and ablation catheters inside the patient's heart and pericardial space when used in conjunction with a Stereotaxis RMNS.

Companion magnetic navigation system

The *Cardiodrive* system works in conjunction with a magnetic navigation system. The physician uses the RMNS to steer the distal tip of the catheter while the *Cardiodrive* device provides the means for remote advancement or retraction. A companion x-ray system provides real-time guidance for the physician during the interventional procedure as well. The documentation for the RMNS and the x-ray system are not duplicated herein.

The Instructions for Use (IFU) for the *Cardiodrive* disposables are provided in appendixes following the body of this guide and are contained in its binder.

About this user guide







The purpose of this guide is to provide the user of the *Cardiodrive* system with instructions for operating the equipment.

The user guide provides information for configuring, powering up, operating, and shutting down the Stereotaxis *Cardiodrive* system (P/N 001-004115). It also provides information on the installation and maintenance of the *Cardiodrive* unit.



Safety

Although the *Cardiodrive* system provides for remote advancement and retraction of compatible devices, it does not replace the physician's knowledge, expertise, or judgment.

Warnings

-  **WARNING:** Federal (USA) law restricts this device to sale by or on the order of a physician.
-  **WARNING:** The Stereotaxis *Cardiodrive* system should be used only by physicians trained in electrophysiology, interventional cardiology, and in the use of the *Cardiodrive* device and the Stereotaxis magnetic navigation system.
-  **WARNING:** The Stereotaxis *Cardiodrive* system should only be used by physicians trained in electrophysiology, interventional cardiology, and in the use of the *Cardiodrive* device and the Stereotaxis magnetic navigation system.
-  **WARNING:** Always verify catheter motion using live fluoroscopy images. Stop immediately if catheter motion can no longer be verified.
-  **WARNING:** Do not remove covers or attempt to service any of the components of the *Cardiodrive* system. Refer all servicing to qualified service personnel.
-  **WARNING:** Always verify operation of the *Cardiodrive* system before beginning any procedure. Refer to Section 3 of this user guide.

Precautions

-  **CAUTION:** Do not bring the Motor Assembly within 2 feet of the magnet used in the magnetic navigation system.
-  **CAUTION:** When performing a retrograde approach to the left heart via the ascending aorta, please cross the aortic valve and the mitral valve manually, not by the *Cardiodrive* component of the Stereotaxis RMNS.
-  **CAUTION:** As with manual catheter advancement, when advancing the catheter with *Cardiodrive* system, the catheter speed should be decreased to an appropriate speed when approaching vascular structure (such as pulmonary veins) or coronary artery/vein ostia. As a reminder, the maximum advancement speed of the *Cardiodrive* device is 2.0 cm/second.

Electromagnetic compatibility information



WARNING: The use of accessories, transducers, and cables other than those specified, with the exception of transducers and cables sold by Stereotaxis, Inc., may result in increased emissions or decreased immunity of the *Cardiodrive* system.



WARNING: The *Cardiodrive* system should not be used adjacent to or stacked with other equipment and, if adjacent or stacked use is necessary, the *Cardiodrive* system should be observed to verify normal operation in the configuration in which it will be used.

Emissions

The *Cardiodrive* system is intended for use in the electromagnetic environment specified in the following tables. The customer or the user of the *Cardiodrive* system should ensure that it is used in such an environment.

The following table provides guidance and Stereotaxis' declaration on **electromagnetic emissions** for the *Cardiodrive* system:

Emissions	Compliance	Electromagnetic environment—guidance
RF emissions CISPR 11	Group 1	The <i>Cardiodrive</i> system uses RF energy only for its internal function. Therefore, its RF emissions are very low and are not likely to cause any interference in nearby electronic equipment.
RF emissions CISPR 11	Class A Complies	
Harmonic emissions IEC 61000-3-2		
Voltage fluctuations/ flicker emissions IEC 61000-3-3		



WARNING: The EMISSIONS characteristics of this equipment make it suitable for use in industrial and hospital (CISPR 11 class A) settings. If it is used in a residential environment (for which CISPR 11 class B is normally required), this equipment might not offer adequate protection to radio-frequency communication services. The user might need to take mitigation measures, such as relocating or re-orienting the equipment.

Immunity—General electromagnetic effects

The following table provides guidance and Stereotaxis' declaration on **electromagnetic immunity** regarding general electromagnetic effects for the *Cardiodrive* system:

Immunity test	IEC 60601 test level*	Compliance level*	Electromagnetic environment—guidance
Electrostatic discharge (ESD) IEC 61000-4-2	± 6 kV contact ± 8 kV air	± 6 kV contact ± 8 kV air	Floors should be wood, concrete, or ceramic tile. If floors are covered with synthetic material, the relative humidity should be at least 30%.
Electrical fast transient/burst IEC 61000-4-4	± 2 kV for power supply lines ± 1 kV for input/output lines	± 2 kV for power supply lines ± 1 kV for input/output lines	Mains power quality should be that of a typical commercial or hospital environment.
Surge IEC 61000-4-5	± 1 kV line(s) to line(s) ± 2 kV line(s) to earth	± 1 kV line(s) to line(s) ± 2 kV line(s) to earth	Mains power quality should be that of a typical commercial or hospital environment.
Voltage dips, short interruptions and voltage variations on power supply input lines IEC 61000-4-11	<5 % U_T (>95 % dip in U_T) for 0.5 cycle 40 % U_T (60 % dip in U_T) for 5 cycles 70 % U_T (30 % dip in U_T) for 25 cycles <5 % U_T (>95 % dip in U_T) for 5 s	<5 % U_T (>95 % dip in U_T) for 0.5 cycle 40 % U_T (60 % dip in U_T) for 5 cycles 70 % U_T (30 % dip in U_T) for 25 cycles <5 % U_T (>95 % dip in U_T) for 5 s	Mains power quality should be that of a typical commercial or hospital environment. If the user of the <i>Cardiodrive</i> system requires continued operation during power mains interruptions, it is recommended that the <i>Niobe</i> ES System be powered from an uninterruptible power supply or a battery.
Power frequency (50/60 Hz) magnetic field IEC 61000-4-8	3 A/m	3 A/m	Power frequency magnetic fields should be at levels characteristic of a typical location in a typical commercial or hospital environment.

* U_T is the a.c. mains voltage before application of the test level.

Immunity—RF interference

The following table provides guidance and Stereotaxis' declaration on **electromagnetic immunity** regarding RF frequency for the *Cardiodrive* system:

Immunity test	IEC 60601 test level	Compliance level	Electromagnetic environment—guidance
<p>Conducted RF IEC 61000-4-6</p>	<p>3 Vrms 150 kHz to 80 MHz</p>	<p>3 V</p>	<p>Portable and mobile RF communications equipment should be used no closer to any part of the <i>Cardiodrive</i> system, including cables, than the recommended separation distance calculated from the equation applicable to the frequency of the transmitter.</p> <p>Recommended separation distance $d = 1.2\sqrt{P}$ $d = 1.2\sqrt{P}$ 80 MHz to 800 MHz $d = 2.3\sqrt{P}$ 800 MHz to 2.5 GHz</p> <p>where P is the maximum output power rating of the transmitter in watts (W) according to the transmitter manufacturer and d is the recommended separation distance in meters (m).</p> <p>Field strengths from fixed RF transmitters, as determined by an electromagnetic site survey,^a should be less than the compliance level in each frequency range.^b</p> <p>Interference may occur in the vicinity of equipment marked with the following symbol :</p> <div style="text-align: center;">  </div>
<p>Radiated RF IEC 61000-4-3</p>	<p>3 V/m 80 kHz to 2.5 GHz</p>	<p>3 V/m</p>	

Note 1: At 80 MHz and 800 MHz, the higher frequency range applies.

Note 2: These guidelines may not apply in all situations. Electromagnetic propagation is affected by absorption and reflection from structures, objects, and people.

^a Field strengths from fixed transmitters, such as base stations for radio (cellular/cordless) telephones and land mobile radios, amateur radio, AM and FM radio broadcast, and TV broadcast cannot be predicted theoretically with accuracy. To assess the electromagnetic environment due to fixed RF transmitters, an electromagnetic site survey should be considered. If the measured field strength in the location in which the *Cardiodrive* system is used exceeds the applicable RF compliance level above, the *Cardiodrive* system should be observed to verify normal operation. If abnormal performance is observed, additional measures may be necessary, such as re-orienting or relocating the *Cardiodrive* system or needing to contact the TeleRobotic Support Team.

- ^b Over the frequency range 150 kHz to 80 MHz, field strengths should be less than 3 V/m.

Separation distances

The *Cardiodrive* system is intended for use in the electromagnetic environment in which radiated RF disturbances are controlled. The customer or the user of the *Cardiodrive* system can help prevent electromagnetic interference by maintaining a minimum distance between portable and mobile RF communications equipment (transmitters) and the *Cardiodrive* system as recommended in the following table, according to the maximum output power of the communications equipment.

Rated maximum output power of transmitter* W	Separation distance according to frequency of transmitter m		
	150 kHz to 80 MHz $d = 1.2\sqrt{P}$	80 MHz to 800 MHz $d = 1.2\sqrt{P}$	800 MHz to 2.5 GHz $d = 2.3\sqrt{P}$
0.01	0.12	0.12	0.23
0.1	0.38	0.38	0.73
1	1.2	1.2	2.3
10	3.8	3.8	7.3
100	12	12	23

Definitions



The glossary in **Table 1** defines terms in this user guide.

Table 1. Glossary

Term	Explanation
Advance	Forward direction of travel of the device being controlled
Advancer Unit	Disposable component that attaches <i>Cardiodrive</i> unit to the device to be advanced or retracted
CAS	<i>Cardiodrive</i> catheter advancement system
EP	Electrophysiology
IFU	Instructions for Use
RMNS	Robotic magnetic navigation system
Motor	<i>Cardiodrive</i> component that provides the mechanical force to move the device
Retract	Backward direction of travel of the device being controlled





Graphics and Symbols











The following graphical symbols (**Table 2**) are used in this document and/or on *Cardiodrive* components:

WARNING		WARNING indicates a potentially hazardous situation which, if not avoided, could result in death or serious injury.
CAUTION		CAUTION indicates a potentially hazardous situation which, if not avoided, could result in injury to patient or operator or damage to the equipment.
Note		Note identifies information that could affect the outcome or results of the procedure.

Warnings and Cautions precede the text and any procedure involving a clear risk to the operator(s), the patient, or the equipment. General warnings are listed in the Warnings and Precautions summary, which can be found in the *Safety* section. Pay close attention to the instructions that accompany the warnings, notes, and symbols.

Table 2. Graphics and symbols

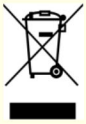
Symbol	Name	Description
	AC Power	Indicates the status of the AC power.
REF	Catalogue Number	Catalogue/part number.
	Caution	Indicates the need for the user to consult the instructions for use for important, cautionary information such as warnings and precautions that cannot be presented on the medical device.
	CE Marking	Product conforms to European Medical Directive 93/42/EEC and meets applicable healthy, safety, and environmental requirements. If the mark is accompanied by a number, conformity is valid.
	Consult Instructions	See the Operating Instructions for additional information or instruction.

Symbol	Name	Description
	Date of Manufacture	The date when the medical device was manufactured.
	European Representative	Name and address of the authorized representative in the European Community.
	Importer	Name and address of the entity importing the medical device into the locale.
	Magnet Present	Indicates a magnet is present in the equipment.
	Manufacturer	Name and address of the manufacturer of the product.
	Medical Device	Indicates the item is a medical device.
	Pinch Point	Indicates location of a pinch point.
	Power	Indicates the power status of the component or system.
	Prescription Only	Caution: Federal law restricts this device to sale by or on the order of a physician.
	Recycle: Electronic Equipment	Product that is subject to the European Union's Waste Electrical and Electronic Equipment (WEEE) 2002/96/EC/EU Directive for recycling of electronic equipment.
	Refer to Instruction Manual/Booklet	The instruction manual or booklet must be read.

Symbol	Name	Description
SN	Serial Number	The manufacturer's serial number so a specific medical device can be identified.
UKRP	UK Responsible Person	A person established in the United Kingdom (UK) who acts on the behalf of a non-UK established manufacturer in relation to the manufacturer's obligations under UK regulations.

Configuring the *Cardiodrive* System

System components

The *Cardiodrive* system consists of three main components:

Motor Assembly (030-005115)

The Motor Assembly contains the motor, which turns the flexible drive cable that connects to the disposable catheter Advancer Unit.

Advancer Unit (001-001751-1)

The *Cardiodrive* system is used with the disposable Advancer Unit (**Figure 1**), which contains the drive assembly for the catheter. The catheter is placed inside the Advancer Unit (also known as the *QuikCAS* device) before the procedure.

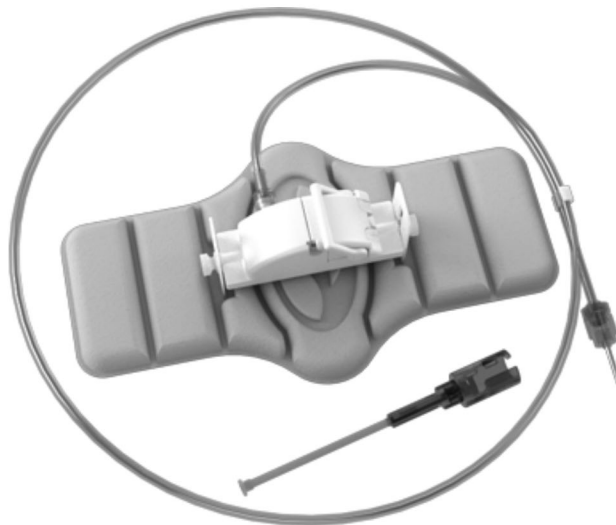

Figure 1. *Cardiodrive* Advancer Unit



WARNING: Do not connect *Cardiodrive* components together while power is applied. Turn off the power before connecting the *Cardiodrive* system.

System interconnection

The *Cardiodrive* system is to be configured so the Motor Assembly is mounted to the patient table rail. The disposable Advancer Unit is attached to the patient's leg. The flexible drive cable is installed between the Motor Assembly and the Advancer Unit. The catheter is installed inside the disposable advancer itself. **Figure 2** displays the interconnection diagram for the *Cardiodrive* system.

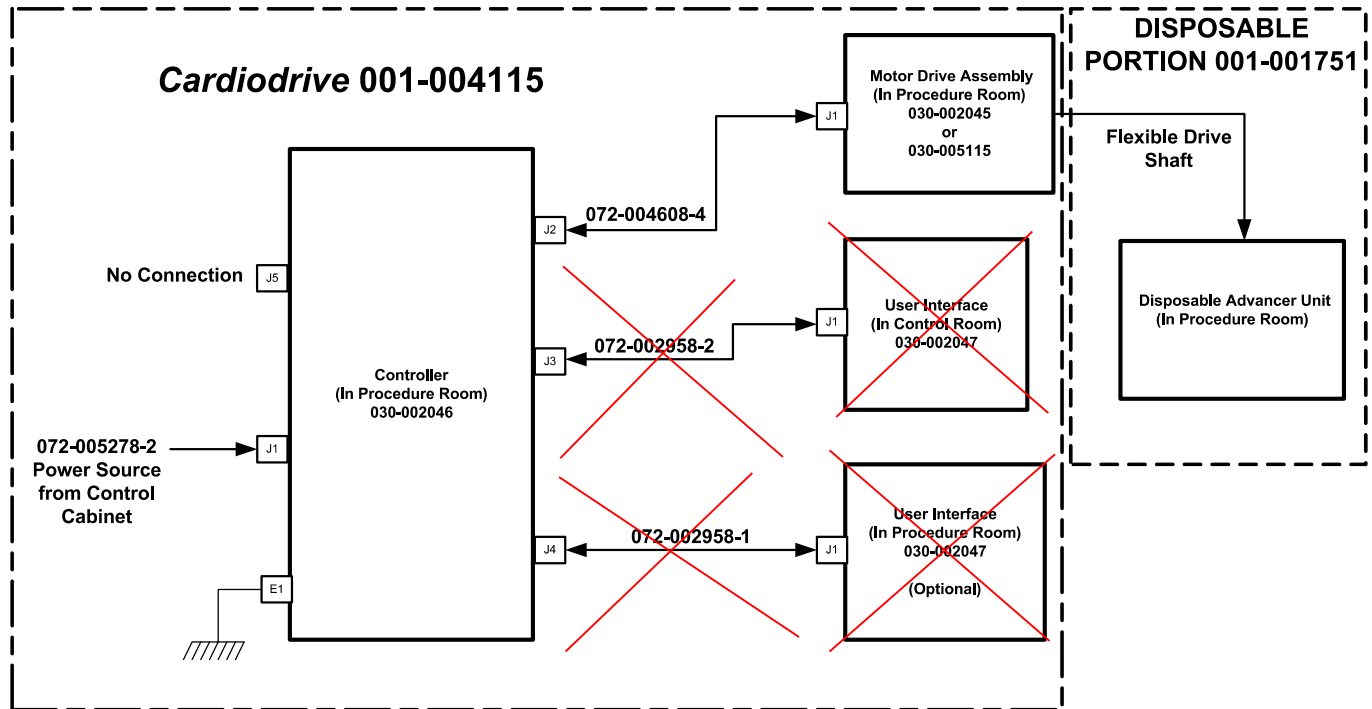

Figure 2. *Cardiodrive* interconnect diagram

Installing the Controller (030-002046)

- Depending on the facility power, the Controller will operate from a 230Vac/60Hz or a 230Vac/50Hz single-phase power source. Verify the power cord is correct for the facility power source and securely installed into the J1 connector of the Controller.
- Verify the grounding stud, E1, is connected to the facility equal potential ground.
- Verify the correct fusing is installed into the AC power inlet. Refer to 985-004663.
- Verify the cable (072-004608-4) is securely installed between the J2 connector of the Controller and the J1 connector of the Motor Assembly.
- Verify the cable (072-002958-2) is securely installed between the J3 connector of the Controller and the J1 connector of the UI in the Control Room.

- Verify the cable (072-002958-1) is securely installed between the J4 connector of the Controller and the J1 connector of the UI in the Procedure Room.

Installing the Motor (030-005115)

- Attach the Motor Assembly to the patient table rail:
 1. Attach the assembly to the rail that is on the patient's left side (while the patient is lying on his or her back).
 2. Attach the assembly so the motor shaft points toward the patient's head (not toward the feet).
- The motor can be slid along the rail as needed. Its exact position should be adjusted with each patient to take the slack out of the flexible drive cable. This position along the rail varies from patient to patient. Attempt to place it as far toward the patient's feet as practical.

Installing the Disposable Advancer Unit (001-001751-1)

- Refer to the Advancer Unit IFU (**Error! Reference source not found.**) for installation of the disposable.
- Slide the motor along the patient table rail (toward the patients head or feet) as necessary to take out slack in the flexible drive cable and keep it as straight as possible for a given patient. Attempt to place it as far toward the patient's feet as practical.

Cardiodrive Instructions for Use

Powering up Cardiodrive unit

- Ensure the power is off.
- Verify all cables are securely fastened to their appropriate connectors.
- Turn on the system power.
- Test all of the following operations to ensure proper device functioning *before* each use in a surgical procedure.

Powering down Cardiodrive unit

To power down the *Cardiodrive* unit, turn off the system power. When powering the *Cardiodrive* unit back up, repeat the steps defined in Section 0.

Performance specifications

Table 3 summarizes the performance specifications for the *Cardiodrive* unit.

Table 3. CAS performance specifications

Parameter	Specification
Velocity for 1mm / 3mm discrete movement	2.0 cm/sec, maximum
Velocity for <i>Navigant</i> -controlled movement	2.0 cm/sec, maximum
Acceleration for all movement	6.25 cm/sec ² , maximum

Additional information

Upon request, Stereotaxis will make available circuit diagrams, component part lists, descriptions, calibration instructions, or other information to assist the user's appropriately qualified technical personnel in repairing the parts of the *Cardiodrive* unit designated by Stereotaxis as repairable.

Cardiodrive Maintenance

This section outlines the basic procedures for maintenance of the *Cardiodrive* system.

Cleaning

Do not autoclave any of the *Cardiodrive* components. The *Cardiodrive* electrical equipment is designed to be wiped down with a cloth or swab dampened in common hospital disinfectants. Never submerge any components of the *Cardiodrive* system.

General safety

The *Cardiodrive* unit is designed to accept power from a single-phase power source of nominally 230 VAC at 60Hz or 230 VAC at 50Hz. To prevent electrical hazards to all personnel, properly ground the *Cardiodrive* unit.

Index

A	
About user guide	7
Advancer Unit	12, 16, 17, 18
C	
<i>Cardiodrive</i> system	
About	7
Components	16
Configuring	16
Electromagnetic compatibility information	8
Intended use	7
Maintenance	19
Safety	8
CAS	12
Cleaning components	19
Companion system	7
Contact Stereotaxis	ii
Contents	v
D	
Definitions	12
E	
EC Rep	ii
EC Representative	ii
Electromagnetic compatibility information	8
Electromagnetic immunity	10
EMC Directive Statement	iii
Emissions	9
F	
Figures	vi
G	
General safety	19
I	
IFU	See Instructions for Use
Instructions for Use	7, 12, 18
M	
Magnetic navigation system	7
Motor Assembly	8, 16, 17
P	
Patents	ii
Powering down <i>Cardiodrive</i> unit	18
Powering up <i>Cardiodrive</i> unit	18
Precautions	8
Q	
<i>QuikCAS</i> Device	16, 18
R	
Related documents	iii
Requesting information	19
RF interference immunity	10
S	
Safety	8
Separation distances	12
Symbols	13
System components	16
System interconnection	17
T	
Tables	vi
Trademarks	iii
U	
User Interface	
Performance specifications	18
W	
Warnings	8
Waste and Recycling	iv

Refer to the change control in the quality management system for the electronic signatures.

Date of Last Signature:21-Feb-2023 21:32 (GMT)