

Document No.: HDW-358, Revision: H
Effective Date: 14 Jul 2021

GENESIS **RMN** ROBOTIC MAGNETIC NAVIGATION

User Guide



4320 Forest Park Avenue
Suite 100
St. Louis, MO 63108
USA
1-866-646-2346
1-314-678-6100

www.stereotaxis.com

© Stereotaxis 2020

R_{only}
CE 2797

Contact Us

Stereotaxis, Inc.
4320 Forest Park Avenue
Suite 100
St. Louis, MO 63108
USA
www.stereotaxis.com
1-314-678-6100 (*Stereotaxis — US*)
0031.75.77.133.13 (*Stereotaxis — EU*)
1-314-678-6200 (*TeleRobotic Support Team — US*)
1-866-269-5268 (*TeleRobotic Support Team — US*)



European Authorized Representative

MDSS
(Medical Device Safety Service GmbH)
Schiffgraben 41
30175 Hannover, Germany



Patents

Genesis RMN

Manufactured under one or more of the following United States patents:
7,774,046

Navigant

Manufactured under one or more of the following United States patents:
7,516,416; 7,537,570; 7,540,288; 7,540,866; 7,543,239; 7,627,361; 7,630,752;
7,657,075; 7,708,696; 7,751,867; 7,756,308; 7,761,133; 7,769,428; 7,831,294;
7,853,306; 8,024,024; 8,192,374; 8,369,934; 8,721,655; 9,314,222

Manufactured under the following European patent:

EP 1 682 024 issued in Germany, France, and Great Britain; EP 1 769 390, issued in Germany, France, and the United Kingdom

Other patents issued and pending.

Stereotaxis Trademarks

- *Genesis RMN* is a trademark of Stereotaxis, Inc., registered in the United States.
- *Cardiodrive* and *Navigant* are trademarks of Stereotaxis, Inc., registered in the United States, the European Community, the United Kingdom, and Japan.
- *Odyssey* is a trademark of Stereotaxis, Inc., registered in the United States, the European Community, and the United Kingdom.
- *Odyssey Cinema* is a trademark of Stereotaxis, Inc., registered in the European Community and the United Kingdom.
- *Odyssey Vision* and *Vdrive* are trademarks of Stereotaxis, Inc.

Other Trademarks

- CARTO3, Navistar, Thermocool, Celsius, and Celsius Thermocool are registered trademarks of Biosense Webster.
- AcQMap is a registered trademark of Acutus Medical.

All other brand names, product names, and/or trademarks found in this document are the property of their respective owners.

EMC Directive Statement

EMC Directive Compliance	This equipment was tested and found to conform to the Medical Directive 93/42/EEC for electromagnetic compatibility. Compliance with this Directive is based upon compliance with the following harmonized standards:
Emissions:	IEC 60601-1-2 ed 4.0 (2014-02) CISPR11 ed 6.1 (2016-06), Class A (Professional Healthcare Facility Environment)
Immunity:	IEC 60601-1-2 ed 4.0 (2014-02), IEC 61000-4-2 ed 4.0 (2008-12), IEC 61000-4-3 ed 3.2 (2010-04), IEC 61000-4-4 ed 3.0 (2012-04), IEC 61000-4-5 ed 3.0 (2014-05) + AMD:2017, IEC 61000-4-6 ed 4.0 (2014 COR2015), IEC 61000-4-8 ed 2.0 (2009-09), IEC 61000-4-11 ed 2.0 (2004-03) + AMD1:2017

When operating this equipment, verify that other devices installed near it conform to the applicable EMC standards for that device. The *Genesis RMN* System is designed to be installed and operated in a Professional Healthcare Facility Environment.

Safety Standard Statement

Safety Standard Compliance	This equipment was tested and found to conform to the following IEC 60601-1 Medical Electrical Equipment General Requirements for basic safety and essential performance test specifications:
Standard	CAN/CSA-C22.2 No. 60601-1:14 ANSI/AAMI ES60601-1:2005+A2 (R2012) +A1 IEC 60601-1: 2005 + CORR. 1:2006 + CORR. 2:2007 + AM1:2012 (or IEC 60601-1: 2012 reprint)

Related documents

HDW-0352 Genesis Preventive Maintenance and Service Guide
HDW-0356 Troubleshooting Guide for Genesis with Siemens
HDW-0357 Genesis Education and Magnet Safety Manual
HDW-0361 Genesis Automatic Positioner Centering
HDW-0362 Quick Reference for Genesis with Siemens
HDW-0364 Quick Reference for Genesis with Stereotaxis Imaging Model S
HDW-0366 Troubleshooting Guide for Genesis with Model S
HDW-0372 Navigant User Guide
Respective documentation for compatible devices and/or systems.

Operating conditions

Temperature: 15°C to 30°C
Humidity: 20% to 75%, non-condensing
Atmospheric pressure: 70 kPa to 106 kPa

Storage and transport conditions

Temperature: -10°C to 50°C
Humidity: 20% to 95%
Atmospheric pressure: 70 kPa to 106 kPa

Equipment information

Genesis, Siemens Reference number 001-011000-1
Genesis, Model S Reference number 001-011000-3
Classification: Class I Medical Electrical equipment



Note: No class B applied parts. Class B limits used for patient leakage. No class BF applied parts.

Degree of protection: IPX0
Mode of operation: Continuous
Electrical ratings:

Voltage rating:	400/480 V _{AN} 
Current rating:	12/10 A
Frequency:	50 / 60 Hz

The hospital will provide a disconnect device that removes all power to the *Genesis RMN* System when activated.



WARNING: No modification of this equipment is allowed. No user-serviceable parts are inside *Genesis RMNS*. The user should not attempt to disassemble any portion of the *Genesis RMNS*.



WARNING: To avoid the risk of electric shock, this equipment must only be connected to a supply mains that have a protective earth ground.

Operator-accessible disconnect device

In accordance with NEC article 517-72(b), the equipment circuit breaker(s) must be located in a readily operable manner from within the equipment control area. If this is impossible or impractical, a shunt trip circuit breaker with an emergency off push button mounted in the Control Room is acceptable to meet operability requirements.

Pressing the Control Room Emergency Stop button removes power from the Stereotaxis equipment and activates the Siemens X-ray E-stop.



Note: The hospital facility is responsible for installation of this disconnect device.

Waste and Recycling

A contractor is responsible for the disposal and recycling of magnetic materials, scrap metals and electronics found in the Genesis RMN System.

Suggested Contractor: Walch Recycling & Edelmentalle

Accessories

Accessory	Part Number
Cardiodrive	001-004115-9

Notice to the User and/or Patient

Any serious incident that has occurred in relation to the device should be reported to the manufacturer and the competent authority of the Member State in which the user and/or patient is established.

Cover art

Cover art © 2020 Stereotaxis, Inc.

Contents

1. Overview	1
Introduction	1
About This User Guide	1
Companion Systems	1
Indications	2
Contraindications	3
Graphics and Symbols	3
Glossary.....	4
Safety.....	6
Warnings	6
Precautions	8
Technical Details and System Testing	10
Electromagnetic Compatibility Information	13
Emissions.....	14
Immunity—General electromagnetic effects.....	14
Immunity—RF interference.....	15
Separation distances	17
2. Basic Information.....	18
<i>Genesis RMNS</i> Magnet Information.....	18
<i>Genesis RMN</i> Magnet Positions.....	19
System positions.....	19
Universal Tableside Controller (UTSC).....	23
System Power Up.....	24
Preparing for patient’s entry	24
Recommended Patient Loading Procedure	25
Magnetic safety precautions	25
Patient Table	26
Cover-Force Sensor	27
Automatic positioner centering.....	27
Navigation Procedure Tasks.....	28
Navigate Position Assistance.....	29
Cleaning Instructions.....	32
Cleaning the lab.....	32
Cleaning the <i>Genesis RMN</i> System	32
3. Emergency Operations	33
Emergency Patient Retraction	33
Overriding Magnet Interlocks.....	33
Moving Magnets Manually.....	34

Removing Item Stuck to Magnet	34
4. Troubleshooting	36
Facility breakers.....	36
Index	37

1. Overview

Introduction

The Stereotaxis Genesis Magnetic Navigation System (MNS) is a medical platform designed for electrophysiological and interventional procedures. Genesis MNS facilitates the control of the distal tip of compatible magnetic devices via magnetic fields. Genesis MNS includes the Stereotaxis *Genesis RMN*® System (*Genesis System*) with *Navigant*® Workstation (NWS) (*Navigant*) and the *Cardiodrive*® System. Genesis MNS is an interventional workstation for the intravascular navigation of appropriately equipped, magnetically-adapted devices (e.g., catheters or guidewires) through tissue to designated target sites.

Physicians use computer—controlled permanent magnets, found in the *Genesis RMNS*, to orient or steer the tips of compatible magnetic electrophysiology (EP) mapping and ablation catheters inside the patient's heart. *Genesis RMNS* integrates with *Navigant* software which determines the direction the magnetic field should be applied and allows the physician to remotely advance and retract compatible, magnetically-adapted devices using *Cardiodrive*.

About This User Guide

The purpose of this user guide is to provide the *Genesis RMNS* user with instructions for operating the equipment. The guide describes basic system information, specific functionality, and emergency operations and troubleshooting. This guide covers the following systems:

Genesis RMN Siemens Reference number 001-011000-1

Genesis RMN Model S Reference number 001-011000-3

Companion Systems

Genesis MNS may be used with the following magnetically-compatible devices:

- NAVISTAR® Catheter
- NAVISTAR® RMT THERMOCOOL® Catheter
- Celsius® RMT Catheter
- Celsius® Thermocool® RMT Catheter

Genesis MNS communicates with:

- Biosense Webster® Stockert 70 RF Generator

Genesis MNS communicates with a variety of digital fluoroscopy systems:

- Siemens AXIOM™ Artis™ dFC MN
- Siemens AXIOM™ Artis™ dBC MN
- Stereotaxis Imaging Model S (powered by Omega Imaging)

The Genesis MNS integrates with a compatible, digital fluoroscopy system to provide real-time guidance to the physician during an interventional procedure. The fluoroscopy system must be able to operate in the high magnetic field environment produced by the magnets.

The Genesis MNS communicates with the Stereotaxis *Cardiodrive* system found in the laboratory where the Genesis MNS is installed.

The Genesis MNS and the Biosense Webster CARTO® 3 systems communicate to allow integrated mapping and navigation. The OpenMapping API feature allows communication between Genesis MNS and mapping systems that have been tested to be compatible such as the Acutus AcQMap® High Resolution Imaging and Mapping System.

Documentation for companion systems is provided by the manufacturer, not duplicated here.

Indications

In the United States, the following Indications are applicable for the *Genesis RMN* and *Cardiodrive* systems.

- The *Genesis RMN* System is intended to navigate compatible magnetic devices through tissue to designated target sites in the right and left heart, coronary vasculature, neurovasculature, and peripheral vasculature by orienting the device tip in a desired direction.
- The *Cardiodrive* System is intended to automatically advance and retract compatible magnetic electrophysiology (EP) mapping and ablation catheters inside the patient's heart when used in conjunction with a Stereotaxis MNS.
- The *Cardiodrive* System is not intended to advance the EP mapping and ablation catheters through the coronary vasculature or the coronary sinus.
- The *Cardiodrive* System is not intended to advance or retract non-compatible catheters and/or other non-compatible devices into the neurovasculature.

In all other geographies, the following Indications are applicable for the *Genesis RMN* and *Cardiodrive* systems.

- The *Genesis RMN* System is intended to navigate compatible magnetic devices through tissue to designated target sites in the right and left heart, pericardial space, coronary

vasculature, and peripheral vasculature by orienting the device tip in a desired direction.



- The Stereotaxis *Cardiodrive* System is intended for automatically advancing and retracting compatible magnetic electrophysiology (EP) mapping and ablation catheters inside the patient's heart and pericardial space when used in conjunction with a Stereotaxis MNS.

Contraindications

There are no known contraindications.



Graphics and Symbols







The following graphics and symbols are used in this User Guide:

WARNING		WARNING indicates a potentially hazardous situation which, if not avoided, could result in death or serious injury.
CAUTION		CAUTION indicates a potentially hazardous situation which, if not avoided, could result in injury to patient or operator or damage to the equipment.
Note		Note identifies information that could affect the outcome or results of the procedure.

Warnings and Cautions precede the text and any procedure involving a clear risk to the operator(s), the patient, or the equipment. General warnings are listed in the Warnings and Precautions summary, which can be found in the *Safety* section. Pay close attention to the instructions that accompany the warnings, notes, and symbols.

The following graphical symbols are used in this document and/or on system components:

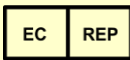
Symbol	Name	Description
	Magnet Present	Indicates a magnet is present in the equipment.
	Consult Instructions	See the Operating Instructions for additional information or instruction.

Symbol	Name	Description
	Power	Indicates the power status.
	E-stop	Indicates the E-stop button or the E-stop indicator light.
	AC Power	Indicates the status of the AC power.
	DC Power	Indicates the status of the internal DC power.
	Manufacturer	Name and address of the manufacturer of the product.
	European Representative	Name and address of the authorized representative in the European Community.
	Pinch Point	Indicates location of a pinch point.

Glossary

The following terms appear in this document:

Term	Description
2D	Two-Dimensional.
3D	Three-Dimensional.
5 Gauss line	See Gauss.
AP	Anterior-Posterior.
C-Arm	An X-ray image intensifier that produces live X-ray images displayed on a monitor and named because of its configuration, with the top part of the C extending over the patient and the bottom extending under.

Term	Description
Cardiodrive System	The Stereotaxis tool that provides the physician with the ability to advance and retract catheters from a Control Room. The full name is <i>Cardiodrive</i> Catheter Advancement System (CAS).
CARTO 3 System	Biosense Webster system that combines 3D mapping and navigation systems with the Stereotaxis Genesis MNS.
CAS	<i>Cardiodrive</i> Catheter Advancement System. (See <i>Cardiodrive</i> System.)
CRT	Cardiac Resynchronization Therapy.
EMC	Electromagnetic compatibility.
EP	Electrophysiology.
Fluoro	Fluoroscopic, or Fluoroscopy.
Fluoroscope	An X-ray image intensifier that produces live X-ray images displayed on a monitor. Also called X-ray or C-Arm.
Fully retracted	Magnet positioners are pivoted toward the patient and at the farthest distance from the patient.
Gauss (G)	The centimeter-gram-second (cgs) unit of magnetic flux density. A 5 Gauss line is marked on the floor of the Procedure Room. < 5 G of static magnetic field exposure for the general public is considered safe.
Genesis Magnetic Navigation System (MNS)	A medical platform that enables physicians to more effectively navigate catheters, guidewires and other magnetic interventional devices through the blood vessels and chambers of the heart to treatment sites and then to effect treatment. The Genesis MNS consists of the <i>Genesis RMN</i> , <i>Navigant</i> , and <i>Cardiodrive</i> systems and is available only in magnetic labs.
Genesis Robotic Magnetic Navigation (RMN) System	A Stereotaxis system consisting of computer-controlled magnets that assist physicians in orienting and steering compatible, magnetically-adapted devices.
IC	Interventional, or Intracardiac, Cardiology.
Isocenter	In X-ray technology, the isocenter is the point in space through which the central ray of the radiation beams pass.
LAO	Left Anterior Oblique
Move button	Upon selecting a magnet position on the UTSC, the user will hold down the Move button to move the magnets into the selected position.

Term	Description
<i>Navigant software</i>	A platform of software applications designed to simplify clinical workflows. The <i>Navigant Workstation (NWS)</i> , excluding the <i>Odyssey</i> add-on, provides enhanced integration of catheterization and electrophysiology labs and improved automation during magnetic navigation of medical devices. (Available only in magnetic labs.)
Navigation volume	Spatial volume defined for RMNS, where the RMNS is capable of generating any magnetic field direction at the target magnetic field strength provided by the RMNS.
Pivoted	Magnet position between Navigate AP and stowed; magnets are pointed away from the patient.
RAO	Right Anterior Oblique.
RF	Radiofrequency.
RMNS	Robotic Magnetic Navigation System (<i>e.g., Genesis RMN System</i>)
RMT	A remote magnetic technology. (RMT is often used to refer to the integrated CARTO 3 / Genesis MNS environment incorporating 3D mapping and navigation and magnetic maneuvering of compatible devices).
Tesla (T)	The standard unit of magnetic flux density.
UTSC	Universal Tableside Controller. Touchscreen controller positioned on the side of the patient table in the Procedure Room.

Safety

Warnings

Although the Genesis MNS provides skill amplification and an automated means of steering the distal tip of catheters and guidewires, these features do not replace the physician's knowledge, expertise, or judgment.



WARNING: Federal (USA) law restricts this device to sale by or on the order of a physician.



WARNING: The *Genesis RMN System* should be used only by qualified medical professionals who have been thoroughly trained in its use. The *Stereotaxis Cardiodrive System* should only be used by physicians trained in the use of these systems, with a thorough understanding of angiography and percutaneous interventional procedures.



WARNING: The *Genesis RMN* System has permanent magnets that **always produce** a strong magnetic field. The field cannot be turned off. This field could cause metal objects in the Procedure Room to become airborne projectiles if not kept sufficiently isolated from the magnetic field. The magnetic field is present in the vicinity of the magnets at all times. Patients and operators with pacemakers, internal cardiac defibrillators (ICD), neurostimulators, or magnetic sensitive or ferromagnetic implants should contact the manufacturer of their respective implant before entering the Procedure Room. Serious injury may result.

Refer to the “Reference Manual for Magnetic Resonance Safety, Implants & Devices” published by Biomedical Research Publishing Group for details on the types of objects and medical implants compatible with magnetic environments.

Individuals near the magnet should remove from their person items that could be affected by magnetic fields, including items with magnetic stripes on them (credit cards, employee badges), wristwatches with mechanical movements, cell phones, and magnetic media such as floppy disks and ferrous materials.



WARNING: The *Genesis RMN* magnets produce a strong magnetic field, which is always on. Patients and operators with pacemakers, internal cardiac defibrillators (ICD), neurostimulators, or magnetic sensitive or ferromagnetic implants should contact the manufacturer of their respective implant before entering the Procedure Room. Serious injury may result.



WARNING: The user should not attempt to upgrade, configure, or run any other software programs on the Genesis MNS computers, other than those specifically mentioned in the product documentation.



WARNING: There are no user serviceable parts inside the *Genesis RMN* magnets. The user should not remove any covers (other than the hand crank covers) or guards, or attempt to disassemble any portion of these magnets.



WARNING: All equipment brought into the Procedure Room (for example, IV poles, patient monitoring equipment, oxygen tanks, etc.) must be safe in a magnetic environment. All equipment that is “MRI compatible” meets these criteria.



WARNING: The operator must not touch the Procedure Room monitor while also touching the patient.



WARNING: When a graphical representation of the catheter tip and shaft on the Genesis MNS display screen, the graphical representation is a display of the calculated catheter shape, based on the initial location and orientation of the catheter base and distance of catheter shaft advancement (or retraction) by the *Cardiodrive* System.



WARNING: *Genesis RMN* does not track the location or orientation of the catheter. (If the user purchases a compatible mapping system, the location and orientation of the catheter tip can be displayed.)



WARNING: The graphical representation of the catheter on the Genesis MNS display screen represents an approximate location and orientation of the catheter inside the patient's heart after the user acquires a new fluoro image and subsequently transfers it from the X-ray using the "Transfer Image" button.



WARNING: Exercise caution with moving parts of the system to prevent inadvertent contact or damage to the patient, operator, or equipment. Movable items include both magnet positioners, the accompanying fluoroscopy system's C-Arm, and the patient table.



WARNING: Genesis MNS should be used only with magnetic devices and accessories appropriately labeled as compatible with MNS applications.



WARNING: Make sure the patient table pivot is in the central position (centered between the magnet pods) before moving the *Genesis RMN* pods out of the Stowed position toward the Navigate position.



WARNING: The operator should always confirm device location using a live fluoroscopic image.



WARNING: If the device is moved manually instead of using the *Cardiodrive* System, the *Cardiodrive* display, and any previously stored position data may become invalid. The physician should remove all previously set markers after moving the device manually.



WARNING: Always verify catheter motion using live fluoroscopy images. Stop immediately if catheter motion can no longer be verified.



WARNING: Ablation system foot pedal should not be connected to the RF generator in the Procedure Room. It is intended for use only in the control room.



WARNING: If unexpected catheter motion occurs during ablation, stop RF energy delivery.



WARNING: If there is a cybersecurity breach during a procedure, press the E-stop button to stop all device activities. Contact the Emergency call center to report the suspicious activity prior to resumption of the procedure.

Precautions



CAUTION: If a patient is to receive a permanent pacemaker or internal cardiac defibrillator (ICD) *de novo* in the Procedure Room, the system magnets must be moved and kept in the Stowed position. The magnets should stay in their Stowed positions during the entire period starting from the moment the ICD or pacemaker is brought inside the Procedure Room, and ending when the patient

(with the ICD or pacemaker implanted) is moved out of the Procedure Room. Proper functioning of ICDs and pacemakers should be verified following the removal of the patient from the Procedure Room.



CAUTION: During patient loading and unloading, there is a collision risk for individuals in the vicinity of the magnet positioners and the X-ray system. All individuals should make sure they are not in this vicinity when the magnets are moving between the Stowed and Navigate positions. An audio signal sounds when magnets have completed their movement. (Volume may be adjusted in Settings → System tab.)



CAUTION: Do not enter the area between the X-ray system and magnet positioner when the magnets are between Pivoted and Stowed position.



CAUTION: Due to space constraints in the Procedure Room in the low magnetic field (< 5 gauss) area, remove one patient before bringing in another.



CAUTION: The Genesis MNS uses a magnetic field to orient the tip of the catheter to the desired intracardiac orientation.



CAUTION: The points on the CARTO 3 System screen are for reference only. Always confirm orientation of the catheter location with localization methods—fluoroscopy, for example—in addition to the electrograms.



CAUTION: The CARTO 3 System points and catheter tip location displayed on the CARTO 3 screen can be transferred to the *Navigant* screen. The catheter tip displayed on the *Navigant* screen is used only as a visual reference to aid navigation, not to identify the location of the catheter tip in the heart. Always confirm orientation of the catheter location with localization methods—fluoroscopy, for example—in addition to the electrograms.



CAUTION: If the physician believes the catheter may be in the wrong location, the physician should refresh the fluoroscopy image. If a discrepancy occurs, the physician should reregister the mapping system to *Navigant*, remark the catheter base, and recalibrate the *Cardiodrive* System.



CAUTION: While the magnet system is homing, varying magnetic fields will be applied in the vicinity of the magnets and the patient table.



CAUTION: Do not enter the area between the C-Arm and magnet when the magnets are in the pivoted position.



CAUTION (Siemens): The *Genesis RMN* and the Siemens X-ray systems have different emergency stop buttons. Pressing the *Genesis RMN* E-stop will activate the X-ray E-stop (via a hardware connection), causing the X-ray to stop. Pressing the X-ray system E-stop will cause the *Genesis RMN* System to stop (via software).



CAUTION (Model S): With Model S, pressing the X-ray system E-stop will cause the *Genesis RMN* System to stop.



CAUTION: If the *Genesis RMN* System is operated with interlocks overridden (as described in the Emergency Operations section), a collision between the *Genesis RMN* System and the X-ray system is possible. Closely monitor the magnet movement, and be ready to release the Move button if a collision is imminent. Failure to heed this caution may cause damage to the equipment.



CAUTION: Although the magnetic field is 0.08T to 0.1T (Tesla) in the navigation volume at isocenter, it is stronger than this in regions closer to the front of the magnets:

- In the Navigate position, the field strength at the flat front surface of the magnet covers can be as high as 0.7T.
- In the Navigate position, the field strength is less than 0.2T five inches (13 centimeters), or more, in front of the front surface of the magnet cover.
- In the Pivoted and Stowed positions, the field strength is less than 0.2T one inch (3 centimeters), or more, in front of the front surface of the magnet cover.
- Field strengths above, below, behind, and to the sides of the magnets are always less than those on the front surface.



CAUTION: Do not set anything on the keypad or flip the keypad over. This will prevent a key from being held down causing unwanted repetitive motion.

Technical Details and System Testing

The *Genesis RMN* System generates a directional 0.08T or 0.1T magnetic field within the patient's heart. The navigation volume is 6 inches (15 centimeters) in diameter centered at X-ray isocenter.

Mechanical Performance Testing

Mechanical performance testing of the compatible catheters included anatomical and deflection target testing. Deflection testing included six separate deflection directions and was performed at five separate positions around the navigation volume. Acceptable performance was reaching anatomical targets and all deflection targets.

Deflection Testing Positions

Pos A - Isocenter

Pos B – Posterior 2 inches (5 centimeters) from A

Pos C – Inferior 2 inches (5 centimeters) from A

Pos D – Patient right 2.5 inches (6 centimeters) from A

Pos E – Patient left 2 inches (5 centimeters) from A

Catheter	Anatomic	Pos A	Pos B	Pos C	Pos D	Pos E
Navistar RMT	Success	Success	Success	Success	Success	Success
Navistar Thermocool RMT	Success	Success	Success	Success	Success	Success
Celsius RMT	Success	Success	Success	Success	Success	Success
Celsius Thermocool RMT	Success	Success	Success	Success	Success	Success

In vivo testing

Navigation to predefined targets with compatible catheters was successfully performed with the following results (threshold < 2.85ma is considered good contact).

Target Anatomy	Navistar RMT		Navistar RMT Thermocool		Celsius RMT		Celsius Thermocool RMT	
	Target Achieved	Pacing Threshold	Target Achieved	Pacing Threshold	Target Achieved	Pacing Threshold	Target Achieved	Pacing Threshold
RA Lateral Wall	yes	0.6	yes	0.7	yes	0.8	yes	0.5
RA Posterior Wall	yes	1.0	yes	0.5	yes	0.2	yes	0.6
LA Pulmonary Vein	yes	n/a	yes	n/a	yes	n/a	yes	n/a
LA Appendage Wall	yes	0.3	yes	1.1	yes	0.4	yes	0.8
RV Lateral Wall	yes	0.3	yes	0.4	yes	0.8	yes	0.9
RV Septum Wall	yes	0.5	yes	1.3	yes	0.4	yes	1.6
LV Lateral Free Wall	yes	0.3	yes	0.4	yes	0.5	yes	1.1
LV Septum Wall	yes	0.4	yes	1.5	yes	0.6	yes	1.1

Fluoroscopy Exposure





Patients and operators will be exposed to fluoroscopy during procedures performed with the *Genesis RMN* System. Operators may experience less exposure because they will be remotely performing the procedure in the control room. Clinical trials using previous versions of magnetic navigation systems reported mean fluoroscopy times ranging from 10.64 minutes to 16.91 minutes.

Cybersecurity

Please note the following important information concerning cybersecurity:

- Cybersecurity controls operate in the background of *Navigant* Workstation. No user actions are required to maintain the security of the system, but any suspected cybersecurity incidents should be reported to the Stereotaxis Telerobotic Support Team (TST).
- Only trusted users should be allowed physical access to the Genesis MNS.
- Confidentiality of system passwords should be maintained. Only trusted users should have access to them.
- Caution should be used when using removable media, e.g., CD, DVD, Blu-ray disks, flash drives, USB hard drives, with Genesis MNS. Independent virus scanning is recommended before insertion or connection to the system.

General Notes

-  Always verify the fluoroscopy images match the current patient.
-  Before ablation, verify the field is applied to ensure proper device functionality.
-  Images electronically zoomed and/or panned cannot be transferred to Genesis MNS.
-  Images acquired during C-Arm or table movement cannot be transferred to Genesis MNS.

C-Arm collision with magnet considerations

When both are powered up, the *Genesis RMN* magnets and the X-ray system are “aware” of each other and their current location. The user will neither be able to move the magnets into an area where the C-Arm is located, nor move the C-Arm into an area where the magnets are located. If the user attempts to do this, a warning message will appear and the controls will be locked out.

The X-ray C-Arm and magnets must **never** physically contact each other, for several reasons:

- The magnetic tube shield around the X-ray tube would stick to the magnet.
- The C-Arm could sustain physical damage.
- The cosmetic covers could sustain physical damage.



CAUTION (Siemens): Siemens collision avoidance is disabled by design when not communicating with the *Genesis RMN* System unless the Siemens System sees that the *Genesis RMN* magnets are in the Stowed position (via hardware signal). When collision avoidance is disabled, the C-Arm will move very slowly, but it is still possible to hit the magnets at this slow speed.



CAUTION (Model S): Model S collision avoidance is disabled by design when not communicating with the *Genesis RMN* System unless the Model S System sees that the *Genesis RMN* magnets are in the Stowed position (via hardware signal). When collision avoidance is disabled, the C-Arm will allow movement to only the AP position and table height movement will be restricted.

Electromagnetic Compatibility Information



WARNING: The use of accessories, transducers, and cables other than those specified, with the exception of transducers and cables sold by Stereotaxis, Inc., may result in increased emissions or decreased immunity of the Genesis MNS.



WARNING: The Genesis MNS should not be used adjacent to or stacked with other equipment. If adjacent or stacked use is necessary, the Genesis MNS should be observed to verify normal operation in the configuration in which it will be used.



Note: In addition to the requirements of 7.9.3 of the general standard for Permanently Installed Large Medical Electrical (ME) Equipment and Large ME Systems for which the exemption specified in 8.6 from the testing requirements of IEC 61000-4-3 is used, this technical description includes the following information:



WARNING: This equipment has been tested for radiated radiofrequency (RF) immunity only at selected frequencies, and use of nearby emitters at other frequencies could result in improper operation. Improper operation may consist of (1) prevention of patient treatment, (2) uncontrolled motion of magnets, and (3) uncontrolled motion of the *Cardiodrive* System.

Following are the frequencies and modulations used to test the Immunity of the ME Equipment or ME System:

- 52.5Mhz
- 144Mhz
- 433Mhz
- 448Mhz
- 452Mhz
- 467Mhz
- 470Mhz
- 1.2Ghz
- 2.4Ghz
- 5.0Ghz

Emissions

The *Genesis RMN* System is intended for use in the electromagnetic environment specified in the following tables. The user of the *Genesis RMN* System should ensure that it is used in such an environment.

The following table provides guidance and Stereotaxis' declaration on **electromagnetic emissions** for the *Genesis RMN* System:

Emissions	Compliance	Electromagnetic environment—guidance
RF emissions CISPR 11	Group 1	The <i>Genesis RMN</i> System uses RF energy only for its internal function. Therefore, its RF emissions are very low and are not likely to cause any interference in nearby electronic equipment.
RF emissions CISPR 11	Class A Complies	
Harmonic emissions IEC 61000-3-2		
Voltage fluctuations/ flicker emissions IEC 61000-3-3		



WARNING: The EMISSIONS characteristics of this equipment make it suitable for use in industrial and hospital (CISPR 11 class A) settings. If it is used in a residential environment (for which CISPR 11 class B is normally required), this equipment might not offer adequate protection to radio-frequency communication services. The user might need to take mitigation measures, such as relocating or re-orienting the equipment.

Immunity—General electromagnetic effects

The following table provides guidance and Stereotaxis' declaration on **electromagnetic immunity** regarding general electromagnetic effects for the *Genesis RMN* System:

Immunity test	IEC 60601 test level*	Compliance level*	Electromagnetic environment—guidance
Electrostatic discharge (ESD) IEC 61000-4-2	± 8 kV contact ± 2, 4, 8 & 15 kV air	± 8 kV contact ± 2, 4, 8 & 15 kV air	Floors should be wood, concrete, or ceramic tile. If floors are covered with synthetic material, the relative humidity should be at least 30%.

Immunity test	IEC 60601 test level*	Compliance level*	Electromagnetic environment—guidance
Electrical fast transient/burst IEC 61000-4-4	± 2 kV for power supply lines ± 1 kV for input/output lines	± 2 kV for power supply lines ± 1 kV for input/output lines	Mains power quality should be that of a typical commercial or hospital environment.
Surge IEC 61000-4-5	± 1 kV line(s) to line(s) ± 2 kV line(s) to earth	± 1 kV line(s) to line(s) ± 2 kV line(s) to earth	Mains power quality should be that of a typical commercial or hospital environment.
Voltage dips, short interruptions and voltage variations on power supply input lines IEC 61000-4-11	<5 % U_T (100 % dip in U_T) for 0.5 cycle 40 % U_T (60 % dip in U_T) for 5 cycles 70 % U_T (30 % dip in U_T) for 25 cycles <5 % U_T (>95 % dip in U_T) for 5 s	<5 % U_T (100 % dip in U_T) for 0.5 cycle 40 % U_T (60 % dip in U_T) for 5 cycles 70 % U_T (30 % dip in U_T) for 25 cycles <5 % U_T (>95 % dip in U_T) for 5 s	Mains power quality should be that of a typical commercial or hospital environment. If the user of the <i>Genesis RMN System</i> requires continued operation during power mains interruptions, it is recommended that the <i>Genesis RMN System</i> be powered from an uninterruptible power supply or a battery.
Power frequency (50/60 Hz) magnetic field IEC 61000-4-8	30 A/m	30 A/m	Power frequency magnetic fields should be at levels characteristic of a typical location in a typical commercial or hospital environment.

* U_T is the a.c. mains voltage before application of the test level.

Immunity—RF interference

The following table provides guidance and Stereotaxis' declaration on **electromagnetic immunity** regarding radiofrequency for the *Genesis RMN System*:

Immunity test	IEC 60601 test level	Compliance level	Electromagnetic environment—guidance
Conducted RF IEC 61000-4-6 Radiated RF	3 Vrms	3 V	Portable and mobile RF communications equipment should be used no closer to any part of the <i>Genesis RMN System</i> , including

Immunity test	IEC 60601 test level	Compliance level	Electromagnetic environment—guidance
IEC 61000-4-3	150 kHz to 80 MHz 3 V/m 80 mHz to 2.7 GHz	3 V/m	cables, than the recommended separation distance calculated from the equation applicable to the frequency of the transmitter. Recommended separation distance $d = 1.2\sqrt{P}$ $d = 1.2\sqrt{P}$ 80 MHz to 800 MHz $d = 2.3\sqrt{P}$ 800 MHz to 2.5 GHz where P is the maximum output power rating of the transmitter in watts (W) according to the transmitter manufacturer and d is the recommended separation distance in meters (m). Field strengths from fixed RF transmitters, as determined by an electromagnetic site survey, ^a should be less than the compliance level in each frequency range. ^b Interference may occur in the vicinity of equipment marked with the following symbol: 
Proximity Fields to RF Wireless Communications	27V/m 380-390Mhz 28V/m 430-470Mhz 800-960Mhz 1700-1990Mhz 2400-2570Mhz 9V/m 704-787Mhz 5100-5800Mhz	27V/m 28V/m 9V/m	

Note 1: At 80 MHz and 800 MHz, the higher frequency range applies.

Note 2: These guidelines may not apply in all situations. Electromagnetic propagation is affected by absorption and reflection from structures, objects, and people.

^a Field strengths from fixed transmitters such as base stations for radio (cellular/cordless), telephones, and land mobile radios, amateur radio, AM and FM radio broadcast, and TV broadcast cannot be predicted theoretically with accuracy. To assess the electromagnetic environment due to fixed RF transmitters, an electromagnetic site survey should be considered. If the measured field strength in the location in which the *Genesis RMN* System is used exceeds the applicable RF compliance level above, the *Genesis RMN*

System should be observed to verify normal operation. If abnormal performance is observed, additional measures may be necessary, such as re-orienting or relocating the Genesis RMN System.

- b Over the frequency range 150 kHz to 80 MHz, field strengths should be less than 3 V/m.

Separation distances



WARNING: Portable RF communications equipment (including peripherals such as antenna cables and external antennas) should be used no closer than 30 cm (12 inches) to any part of the Genesis MNS, including cables specified by Stereotaxis, Inc.

The Genesis MNS is intended for use in the electromagnetic environment in which radiated RF disturbances are controlled. The user of the Genesis MNS can help prevent electromagnetic interference by maintaining a minimum distance between portable and mobile RF communications equipment (transmitters) and the Genesis MNS as recommended in the following table, according to the maximum output power of the communications equipment.

The table provides **recommended separation distances** between portable and mobile RF communications equipment and the Genesis MNS.

Rated maximum output power of transmitter* W	Separation distance according to frequency of transmitter m		
	150 kHz to 80 MHz $d = 1.2\sqrt{P}$	80 MHz to 800 MHz $d = 1.2\sqrt{P}$	800 MHz to 2.5 GHz $d = 2.3\sqrt{P}$
0.01	0.12	0.12	0.23
0.1	0.38	0.38	0.73
1	1.2	1.2	2.3
10	3.8	3.8	7.3
100	12	12	23

* For transmitters rated at a maximum output power not listed above, the recommended separation distance d in meters (m) can be estimated using the equation applicable to the frequency of the transmitter, where P is the maximum output power rating of the transmitter in watts (W) according to the transmitter manufacturer.

Note 1: At 80 MHz and 800 MHz, separation distance for the higher frequency range applies.

Note 2: These guidelines may not apply in all situations. Electromagnetic propagation is affected by absorption and reflection from structures, objects, and people.



Note: If there are Electromagnetic Compatibility (EMC) issues with the Genesis System, contact Stereotaxis TeleRobotic Support Team. There are no specific service requirements to maintain EMC integrity.

2. Basic Information

Genesis RMNS Magnet Information

The arrangement of the magnetic Procedure Room is fairly standard among institutions. The major difference is the X-ray system present. **Figure 1** describes the main Procedure Room components with the X-ray system.

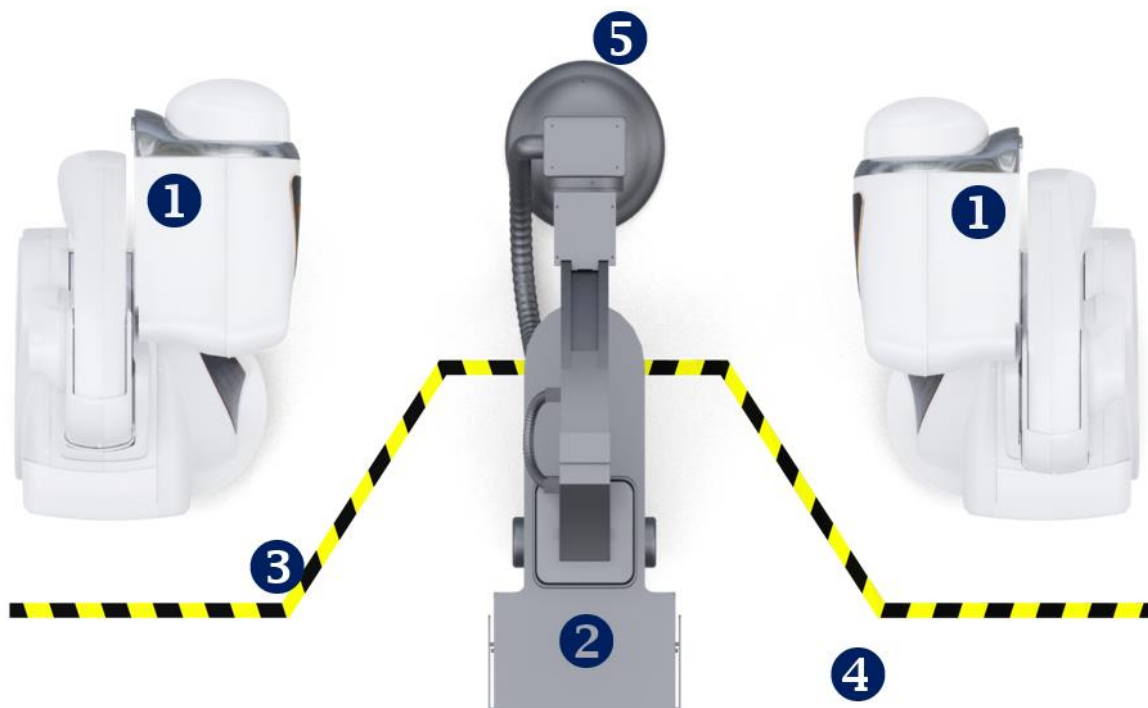

Figure 1. Procedure Room components

Procedure Room component guide (Figure 1)



- ① **Genesis RMNS magnet positioners.** Magnet positioners or *pods* contain system magnets.
- ② **Patient table.**
- ③ **Five Gauss line.** The dividing line between the zones that are less than 5 G and more than 5 G when the magnets are stowed. Institutions indicate this division in various ways.
- ④ **Five Gauss zone.** The zone that is less than 5 G (the table side of the room) within which individuals should remain when magnets are stowed.
- ⑤ **X-ray system.** The compatible digital fluoroscopy system in use.



Genesis RMN Magnet Positions

System positions define the locations of the magnets relative to the patient.

System positions

At any given time, the magnets are in one of the following positions: Stowed, Pivoted, Retracted, or Navigate AP, Navigate RAO, or Navigate LAO. The magnets are moved by pressing buttons on the Universal Tableside Controller (UTSC). The following table describes each of the positions and lists when the various positions are used in a procedure.

Position	Position description	When position is used
<p>Stowed</p>	 <p>Figure 2. Magnets in Stowed position</p>	<ul style="list-style-type: none"> • When no procedure is being performed • During non-magnetic procedures • To allow increased imaging angle flexibility • When greater patient access is needed • When field beyond Physician Access Line needs to be less than 5 G
<p>Pivoted</p>	 <p>Figure 3. Magnets in Pivoted position</p>	<ul style="list-style-type: none"> • When greater patient access is needed • To allow increased imaging angle flexibility
<p>Retracted</p>	<p>Magnets are pointed toward patient; cover-to-cover distance is larger than what is necessary to enable magnetic navigation. When magnets are retracted the maximum distance from patient, system is considered to be in fully Retracted position.</p>	<ul style="list-style-type: none"> • When field needs to be reduced • To allow increased imaging angle flexibility without having to wait for magnets to pivot away from patient • When greater patient access is needed

Position	Position description	When position is used
<p>Navigate AP</p>	 <p>Figure 4. Magnets in Navigate AP</p>	<p>During magnetic navigation procedure with C-Arm angulation centered with respect to patient</p>
<p>Navigate RAO</p>	 <p>Figure 5. Magnets in Navigate RAO</p>	<p>During magnetic navigation procedure with C-Arm angulation on right side of patient</p>
<p>Navigate LAO</p>	 <p>Figure 6. Magnets in Navigate LAO</p>	<p>During magnetic navigation procedure with C-Arm angulation on left side of patient</p>

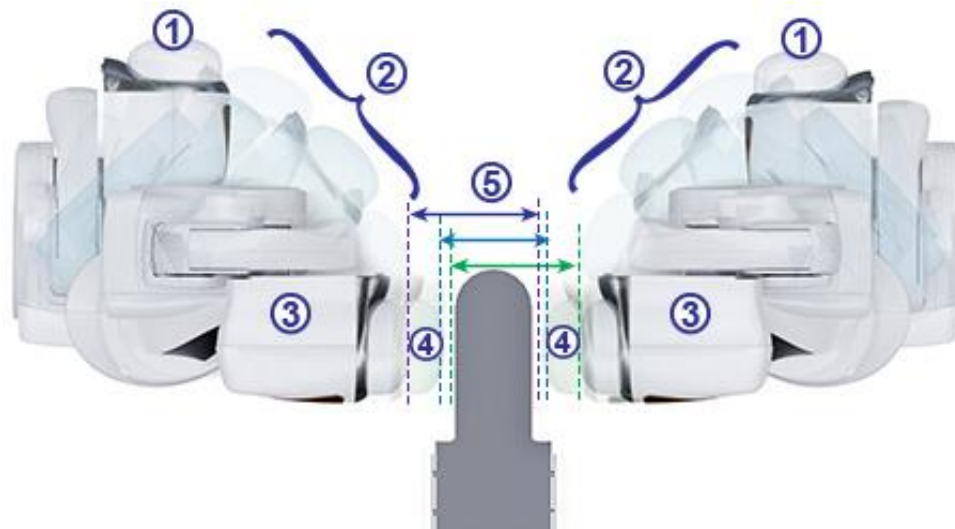

Figure 7. Magnet position options

Magnet positions guide (Figure 7 – Figure 9)

- ① **Stowed**
- ② **Pivoted**
- ③ **Retracted**
- ④ **Extended**
- ⑤ **Cover-to-cover distance**

Magnetic field strength determines the cover-to-cover distance. A force of 0.1 Tesla requires a distance of 23.5 inches (60 centimeters), while 0.08T requires 26.5 inches (67 centimeters). The offset is variable: If the table is not centered and one cover comes too close to the table, the cover will automatically retract and the opposite cover will extend to maintain the same cover-to-cover distance.



Figure 8. Stowed position



Figure 9. Navigate AP position

The magnets move in close proximity to the patient table and the imaging system C-Arm. The user may move the patient table off center to optimize visualization of the desired anatomy for

magnetic navigation. When the **Navigate AP** button is pressed on the UTSC, the magnets will automatically calculate the table position and the cover-to-cover distance required. The user may also manually move each magnet independently to accommodate the change in table position. For example, if the right magnet is moved away from the patient, the left magnet needs to be moved toward the patient until the message *Magnets in Navigate Position* displays on the *Genesis RMN* screen.

The cover position for the last achieved Navigate AP position is stored by the system. Subsequent moves of the magnets to Navigate AP will result in their movement to the stored position. The stored position will be erased if the table is moved, or a new procedure is started.

The approximate time the magnet takes to move between any two positions is listed below. Up to an additional 5 seconds, variation may occur in movements from the Navigate position depending on the magnet position inside the covers:

- Stowed to/from Retracted: 15 seconds
- Retracted to/from Navigate: 5 seconds
- Stowed to/from Navigate: 20 seconds
- Navigate RAO or LAO to/from Retracted: 7 seconds



Figure 10. Pinch hazard areas (red shading)



Note: To prevent collision, all accessories and cables should be clear of magnet movement. The user should note areas labeled for potential pinch hazard as shown in **Figure 10**. Reference source not found..



CAUTION: Do **not** use the UTSC to move magnets when hand crank cover is off. See *Moving Magnets Manually* for manual hand crank operation.

Universal Tableside Controller (UTSC)

The UTSC allows the user to physically move the magnets and controls various other system functions. In the Procedure Room, the user controls the *Genesis RMN* System magnets using the UTSC (**Figure 11**). Once the *Genesis RMN* icon is selected (**Figure 12**), more UTSC buttons display as well as a **Transfer Image** button.



Figure 11. UTSC buttons (left)

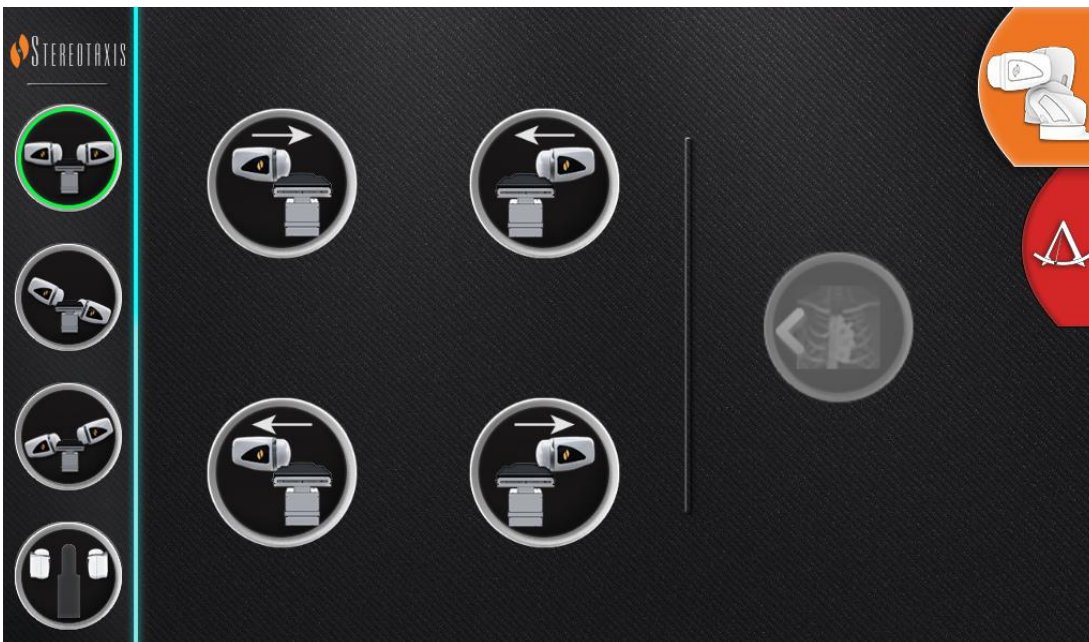









Figure 12. *Genesis RMN* icon selected (right), more UTSC buttons display

Table 1 details the magnet positions that correspond with the UTSC buttons (**Figure 11** and **Figure 12**). The user must select a magnet position on the UTSC and hold down the **Move** button (**Figure 16**) to move the magnets into the desired position.

Table 1. UTSC buttons and descriptions

	Navigate AP		Advance patient right side*
	Navigate LAO		Advance patient left side*
	Navigate RAO		Retract patient right side*
	Stowed		Retract patient left side*

* Applies to patients in head-first supine position.

System Power Up

Preparing for patient's entry

Follow these steps before bringing the patient into the Procedure Room:

1. Ensure no ferrous objects (objects magnets could attract) are in the area.
2. Ensure objects magnets could damage are not in the area, such as credit cards, watches, floppy disks, cell phones, beepers, and hearing aids.
3. Power up the system. On the remote power panel (located in Control Room), hold the toggle switch in the **ON** ("I") position for approximately 1 second until the green power lamp illuminates (**Figure 13**).
4. If not already positioned, retract magnet positioners to Stow by pressing the **Stow** button on the UTSC and the **Move** button (**Figure 16**) to aid in patient loading.

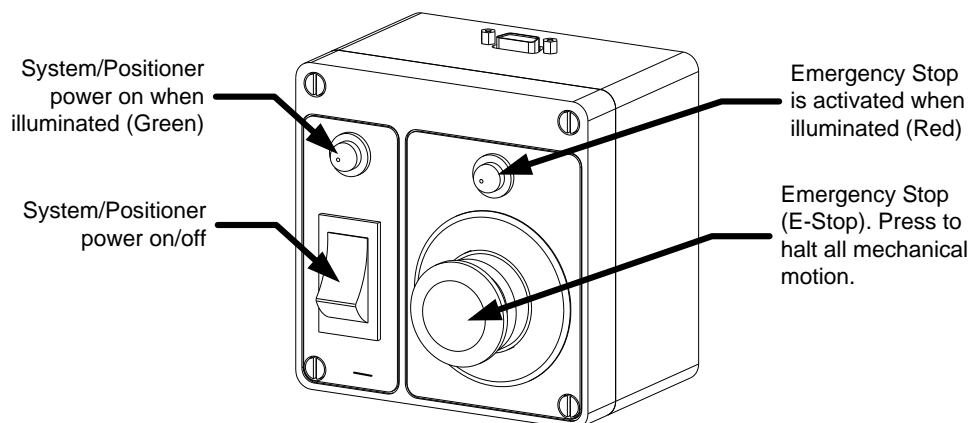



Figure 13. Power Box in Control Room

 **Note:** In case of a voltage interruption, *Genesis RMNS* may shut down, requiring a system restart.

Recommended Patient Loading Procedure

This section outlines the basic steps and precautions for generic and peripheral magnetic navigation procedures.

Magnetic safety precautions

The intent of this procedure is to keep the patient and attending medical staff in a low magnetic field (less than 5 G) while the patient is transferred into and out of the Procedure Room. The 5 Gauss line is marked on the floor. The user should move the magnets into the Stowed position using the UTSC, and move the tabletop back, away from the X-ray system and magnets. Individuals should stay on the table side of the 5 Gauss line when the magnets are stowed.



WARNING: The *Genesis RMNS* produces a strong magnetic field that is always on. Patients and operators with pacemakers, internal cardiac defibrillators (ICD), neurostimulators, or magnetic sensitive or ferromagnetic implants should contact the manufacturer of their respective implant **before** entering the Procedure Room. Serious injury may result if no precautions are taken.

Patient Table

The patient should be centered laterally on the table so the magnets on either side of the table can move toward the patient equally. The table can be moved vertically to adjust the height. See Error! Reference source not found. HDW-0372 *Navigant* User Guide for Error! Reference source not found. specifics regarding the adjustment of table height to match the isocenter height.

The position of the patient on the table depends on the type of procedure performed. Patients should be in a head-first supine position (**Figure 14**) except when a femoral or tibial procedure is performed. For femoral and tibial cases, the patient should be feet-first supine (**Figure 15**).



Figure 14. Head-first supine position



Figure 15. Feet-first supine position

Positioning Patient Guide (Figure 14 and Figure 15)

The patient is loaded feet first for femoral and tibial cases; however, the user must **register the patient “head-first, supine”** for some **Siemens X-ray systems** to ensure proper image transfer. Refer to the X-ray system user guide for instructions regarding feet-first cases.

1. Place the patient on the table in a supine position.
2. Center the patient on the tabletop laterally. Aligning the patient too far off center can interfere with successful automatic positioning of the *Genesis RMNS* magnet covers.
3. Secure the patient’s legs.
4. Secure the patient’s arms. Ensure no part of the arms is below the tabletop to avoid pinching when the magnet positioners move toward the table.
5. Make sure no excess table padding protrudes outside the edge of the tabletop.

Cover-Force Sensor

The magnet covers contain cover-force sensors that detect when the face of the cover is pressing against the patient or padding. When a cover-force sensor is activated, the magnet positioner pauses, then retracts slightly and stops.

If a single cover-force sensor is activated, the operator may choose to continue holding the **Move** button. The system automatically retracts the individual cover that is contacting the patient slightly and advances the opposite cover to continue movement to the Navigate position.



Figure 16. Move button

If the second cover-force sensor is activated before the positioner reaches Navigate position, the Navigate Position Assistance dialog appears. If the second positioner has enough room to reach Navigate position, the *Genesis RMNS* adjusts the Navigate position center based on this new location and displays the status message, "*Magnets in Navigate Position.*"

Automatic positioner centering

The *Genesis RMN* System can automatically center the magnet positioners in the Navigate position, based on the patient table's lateral and vertical positions. To understand this, it is important to first understand the Navigate position and cover-force sensor.

1. Using fluoroscope images, center the patient (region of interest) relative to the X-ray isocenter.
2. Press one of the **Navigate** buttons (the ring around the button will light) on the UTSC. Then press the **Move** button. The system calculates the target position based on the position of the patient table and begins moving to that position.
3. If motion stops and the message *Magnets in Navigate Position* displays in the bottom-left corner of the monitor, the automatic positioner centering has been successful. The system also emits an audio signal that the system is in Navigate position. (The user may adjust the volume in the Settings → System tab.)
4. If the cover contacts the patient and activates the cover sensor, the cover will stop and retract slightly. The other cover's position will adjust to try to reach the Navigate position.
5. If motion stops before the system reaches the Navigate position, one of these conditions has occurred:

- After selecting one of the **Navigate** buttons, the operator did not hold the **Move** button down until the system reached the Navigate Position. The operator may continue to the Navigate Position by pressing and holding the **Move** button.
- Both cover-force sensors have activated. The system displays a message in the bottom-left corner of the monitor and emits an audio signal if the system does not reach Navigate position because of cover-force sensor activation.
- The covers cannot achieve the position because of a potential collision with the table or X-ray system.
- The covers cannot achieve this position because the patient is not centered laterally on the table and one cover is fully extended.

Navigation Procedure Tasks

1. Place the patient on the table as described in *Recommended Patient Loading Procedure*.
2. Prepare the patient per hospital procedure and apply a sterile drape over the tableside user interface.
3. Insert the magnetic catheter or guidewire and advance it to the desired anatomy. The user can advance the device manually or with the *Cardiodrive* System (for approved catheters).
4. Place the X-ray system in the AP, head-side position.
5. Select one of the **Navigate** buttons on the UTSC. Then press and hold the **Move** button to move the magnets to the Navigate or Navigate AP position.
6. Perform the procedure.
7. When the procedure is complete, move the magnets to the Stowed position by pressing the **Stow** button on the UTSC. After which, press and hold the **Move** button until the message *Magnets in Stowed Position* displays.



Note: The system was designed with a safety feature that requires pressing the Navigate button multiple times to give the user an opportunity to double-check patient positioning and safety before moving the magnets.



Note: If the system is unable to reach Navigate position due to a possible collision with the X-ray system or table, a Navigate Position Assistance dialog will display indicating which system components are at risk for a collision.

When the magnetic field direction is defined with the use of any single plane X-ray system, similar to the one employed with the *Genesis RMNS*, the views are acquired simultaneously. However, when two X-ray views are employed, the views are not acquired simultaneously.

As a result, the overlay on the X-ray views is an approximate representation of the magnetic field direction relative to the heart's location. This is because the two X-ray views may have been acquired at different phases in the patient's respiratory and cardiac cycle.

When changes are made to the magnetic orientation of the device tip, confirm the orientation of the device tip with localization methods such as fluoroscopy and electrograms (if using a catheter). If the device tip is not at the desired orientation, update the magnetic field direction and repeat the magnetic navigation procedure if desired.



CAUTION: The *Genesis RMNS* uses a magnetic field to orient the tip of the catheter to the desired intracardiac orientation.

Navigate Position Assistance

The position of equipment (e.g., the table and X-ray arm) in the Procedure Room may interfere with magnet movement. If the system detects a collision risk while the magnets are moving, a Navigate Position Assistance dialog will be displayed. Warning messages associated with the collision risks will be displayed in the dialog. These messages show the system component in red that needs to be adjusted. In the case of a cover sensor activation, either of the magnetic pods will be shown in red (**Figure 17**). After the appropriate adjustment is made to resolve the collision risk, the associated component will be shown in gray. In some cases, adjustments of multiple components may be required to resolve the collision.

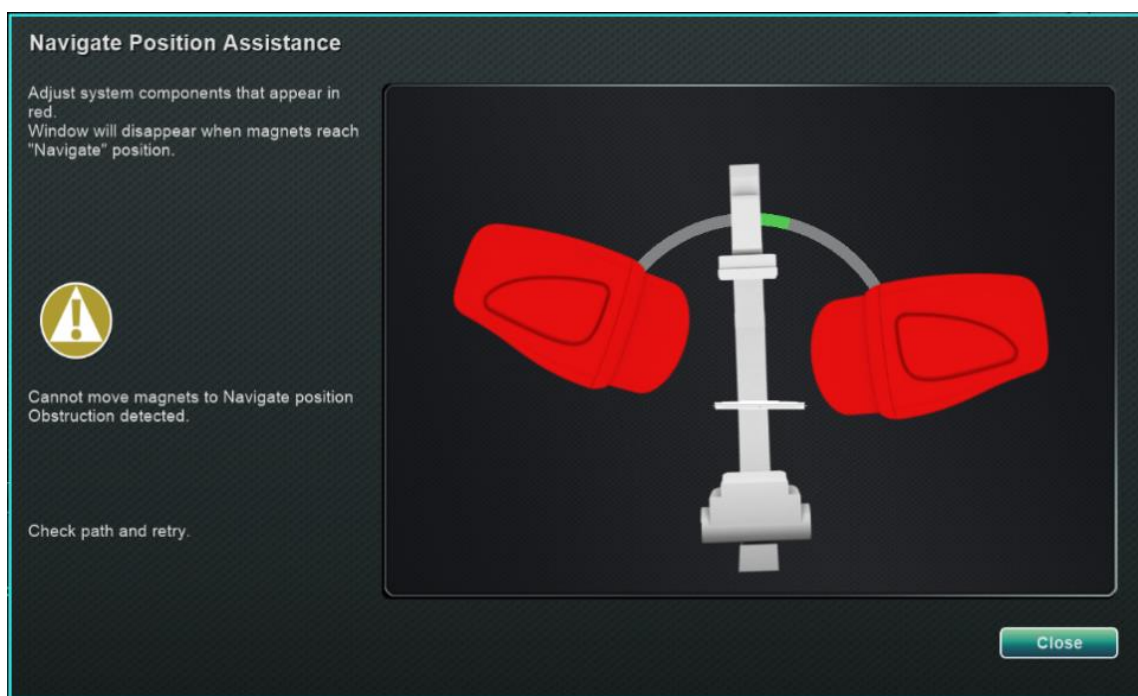

Figure 17. Magnet collision risk message

Once the collision risk has been eliminated, press and hold the **Navigate** button on the UTSC. The dialog automatically disappears after reaching Navigate position. The user is now able to proceed. If it is determined that there are no collision risks, the user may press the **Close** button to remove the dialog.

The green zones in the Navigate Position Assistance dialogs represent regions where the C-Arm or table should be positioned to eliminate the collision risks. In **Figure 18**, the C-Arm is shown in red and needs to be adjusted until it reaches the green zone. Until the C-Arm collision risk is eliminated, the magnets will not move.

In **Figure 19**, the C-Arm has been adjusted into the green zone and is shown in gray. The user may now proceed as there is no collision risk.

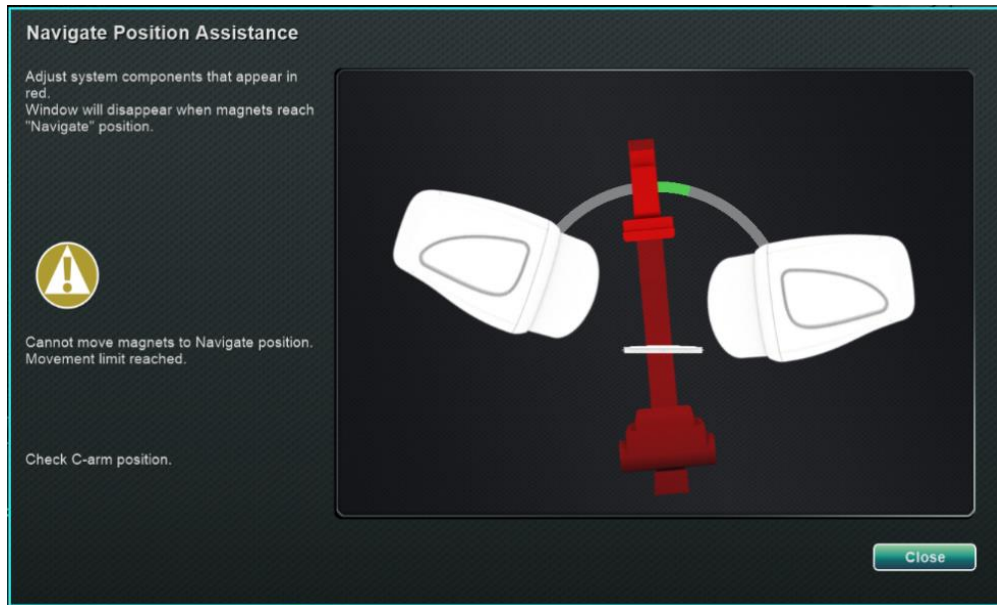

Figure 18. C-Arm collision risk message



Figure 19. C-Arm graphic after C-Arm has been adjusted

In **Figure 20**, the table is shown in red. Before proceeding, adjust the table laterally until it is in the green zone and displays as gray. Once the table is shown in gray, it is safe to proceed as the collision risk has been eliminated.

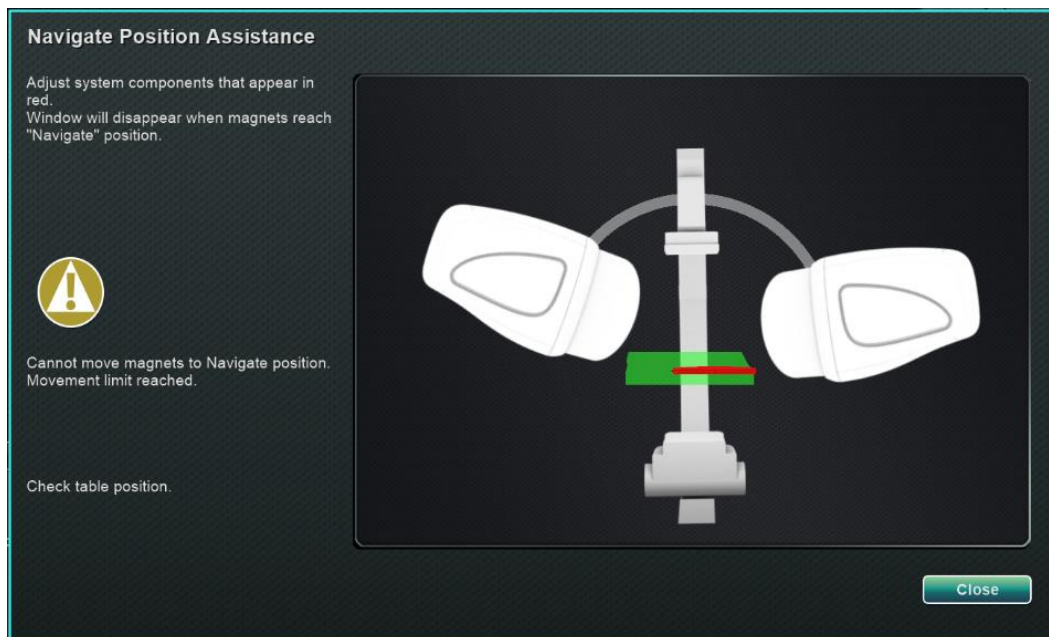

Figure 20. Table collision risk message

Cleaning Instructions

Cleaning the lab

Because the magnetic field in a Stereotaxis lab is always on, caution must be taken while cleaning the lab. MRI-compatible cleaning equipment is recommended, such as mops and brooms without ferrous material in their construction.

To clean the floor under the *Genesis RMNS* pivot the system between the Stowed and Navigate positions using the UTSC.

Cleaning the *Genesis RMN* System

The *Genesis* system can be wiped clean between cases. The cleaning solutions used should be a pH neutral hospital-grade, EPA-registered germicidal solution (e.g., CIDEX® Activated Dialdehyde).

Drapes can be purchased to cover the *Genesis RMNS* and maintain a sterile field on the front of the pods to keep them clean throughout the procedure. Account Managers can assist in purchasing drapes as needed.

3. Emergency Operations

Emergency Patient Retraction

To move the magnets out of the way for an emergency patient retraction, press the **Stowed Position** button on the UTSC and press and hold the **Move** button. Note that the magnets do not have to swing to the full 90° and lock in the Stowed position. The user can release the **Move** button whenever the magnets are sufficiently out of the way. If a power or other failure occurs that keeps the magnets from moving, see **Figure 22** for manual movement of the magnets.

Overriding Magnet Interlocks

System software interlocks prevent the magnet from moving into and colliding with the X-ray system components. The user can override this interlock and move the magnets by simultaneously pressing the **Stow Position** button on the UTSC and pressing and holding the **Move** button. While the **Move** button is held, the magnets are moving and the UTSC will display the message seen in **Figure 21**.

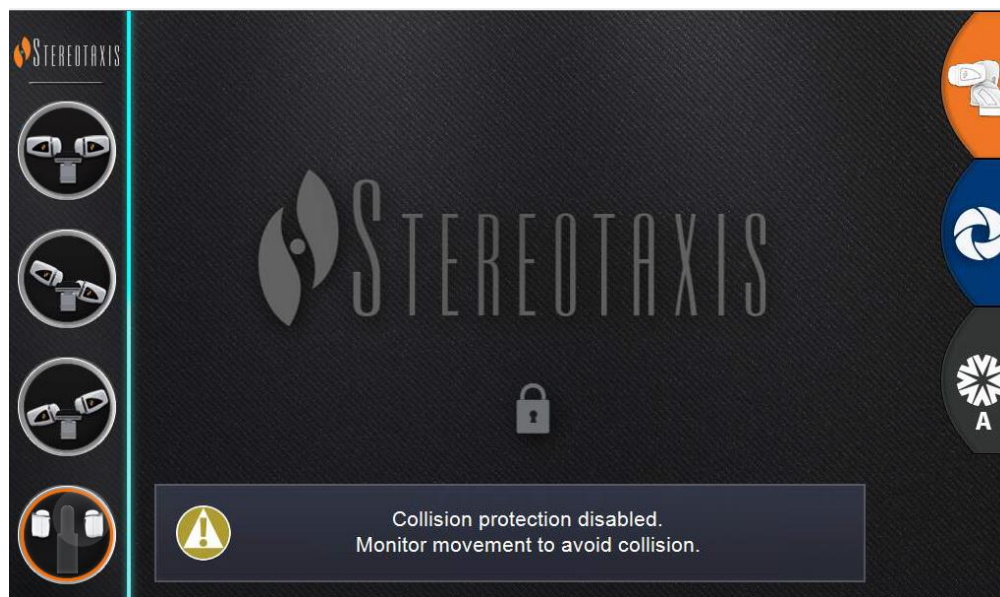

Figure 21. Interlock Override UTSC Message



WARNING: When using the interlock override, visually ensure magnet and X-ray system components will not physically collide. Closely monitor the magnet movement and be ready to release the **Move** button if a collision is imminent. Failure to heed these warnings may cause damage to equipment.

Moving Magnets Manually

A manual hand crank allows the user to manually move the magnets in the event of a facility power failure, or if a mechanical or electrical failure renders the system unable to move normally.



WARNING: When using the manual hand crank, **EXTREME CAUTION** must be taken to ensure proper patient table, C-Arm, and magnet positioning clearance. Also ensure that no one attempts to use the UTSC while manually moving the magnets. Failure to heed these warnings may cause an unsafe condition resulting in personal injury and/or damage to equipment.

To move the magnets manually, follow the steps below that correspond with **Figure 22**. When power is restored and the UTSC is again used, the interlocks will automatically re-engage.

- ① Remove the side cover and set it aside.
- ② Remove hand crank bar from clip.
- ③ Insert bar into the hand crank hole. Make sure hand crank bar is *fully* inserted.
- ④ Turn hand crank bar to pivot magnet.

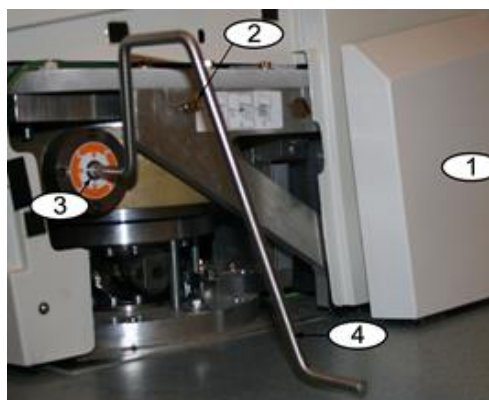

Figure 22. Manual hand crank for magnets

Removing Item Stuck to Magnet

If all safety precautions are followed, ferrous items should never be near the magnet. An incident of something being attracted to and becoming stuck to a magnet should never occur.

However, if an item does become stuck to a magnet, please review the following before attempting removal.

1. The permanent magnets are always “on” and cannot be turned “off.”
2. The larger the mass of the item stuck to the magnet, the harder it will be to remove.
3. Use work gloves or other protective equipment around hands to prevent injury (e.g., skinned or scraped knuckles) when removing large items from a magnet.
4. The magnetic forces are strongest at the front (flat) face of the magnet.
5. The force decays rapidly with increased distance from the front face of the magnet.

6. If the item is sharp, consider potential damage to oneself or others if the user or the item slips, or is re-attracted to the magnet during removal.
7. The general strategy should be to **slide** the item (on the surface of the cosmetic cover) away from the front face of the magnet, and then **quickly and firmly** pull the item away **without hesitation**.
8. Sliding an item toward an outside corner of the cosmetic cover before making the “pull off” attempt over the edge of the cover is most effective.
9. Be aware that the forces around the magnet change. If an item becomes stuck to the magnet and one attempts to move the magnet from the Navigate to the Retracted or Stowed position, the field will change, and the item could fall on its own (or become stuck even firmer).
10. **DO NOT** remove cosmetic magnet covers in an attempt to remove a stuck item. If contacted, the magnet (which the covers protect) could be irreversibly damaged.
11. Contact Stereotaxis TST for assistance if unable to easily, or safely remove an item stuck to a magnet.

4. Troubleshooting

When troubleshooting, the following documents may be referenced:

HDW-0352 Genesis Preventive Maintenance and Service Guide
HDW-0356 Troubleshooting Guide for Genesis with Siemens
HDW-0357 Genesis Education and Magnet Safety Manual
HDW-0361 Genesis Automatic Positioner Centering
HDW-0362 Quick Reference for Genesis with Siemens
HDW-0364 Quick Reference for Genesis with Stereotaxis Imaging Model S
HDW-0366 Troubleshooting Guide for Genesis with Model S

If further assistance is needed, call the **TeleRobotic Support Team (TST)** at 1-314-678-6200 or 1-866-269-5268.

Facility breakers

If the *Genesis RMNS* facility breakers have switched or turned off, contact one of the following:

- The hospital in-house Facilities Department
- Stereotaxis main number
 - 314-678-6100
- Stereotaxis TeleRobotic Support Team:
 - 314-678-6200
 - 1-866-269-5268 (US only)

Index

About user guide.....	1	Magnet positions	22
Accessories	iv	Magnetic safety precautions	26
Automatic positioner centering.....	28	Move button	28
C-Arm collision considerations	12	Navigate AP position.....	21
Companion systems	1	Navigate position assistance.....	30
Contact Stereotaxis	i	Navigation procedure tasks	29
Contents	v	Operating conditions.....	iii
Cover-force sensor	28	Operator-accessible disconnect device ...	iv
EC Rep.....	i	Overview.....	1
EMC Directive Statement.....	ii	Patient loading procedure.....	26
EMC information	13	Patient entry.....	25
Emergency Operations.....	34	Pivoted position	20
Emergency Patient Retraction	34	Power Box.....	26
Moving magnets manually	35	Precautions	9
Overriding magnet interlocks.....	34	Procedure Room components.....	19
Removing item stuck to magnet.....	35	Related documents.....	iii
Equipment information.....	iii	Retracted position	20
E-stop button	iv, 4, 10	Robotic Magnetic Navigation	6
Facility breakers.....	37	Safety.....	6
Fluoro systems	2	Safety Standard Statement	ii
Genesis RMN System		Storage conditions.....	iii
Cleaning	33	Stowed position	20
Drapes.....	33	System power up	25
Magnet Positions	20	Transport conditions	iii
Glossary.....	4	Troubleshooting	37
Graphics and symbols.....	3	UTSC	6, 20, 24
Hand crank.....	35	Warnings	6
Indications	2	Waste and Recycling.....	iv
Introduction	1		