

iCONNECTTM

User Guide



710 N. Tucker Blvd
Suite 110
St. Louis, MO 63101
USA
1-866-646-2346
1-314-678-6100

www.stereotaxis.com

Made In USA

© Stereotaxis 2020, 2023

R_x_{ONLY}
CE 2797

Document No.: HDW-0367
Revision: E, Effective Date: 5 May 2023

iCONNECT User Guide

Contact Us

Stereotaxis, Inc.
710 N. Tucker Blvd
Suite 110
St. Louis, MO 63101
USA
www.stereotaxis.com
1-314-678-6100 (*Stereotaxis — US*)
0031.75.77.133.13 (*Stereotaxis — EU*)
1-314-678-6200 (TeleRobotic Support Team — US)
1-866-269-5268 (TeleRobotic Support Team — US)



European Authorized Representative

MDSS
(Medical Device Safety Service GmbH)
Schiffgraben 41
30175 Hannover, Germany



UK Representative

MDSS-UK RP LIMITED
6 Wilmslow Road, Rusholme
Manchester M14 5TP
United Kingdom
Tel.: 0044 (0)7898 375115



Importer

MedEnvoy
Prinses Margrietplantsoen
33 - Suite 123,
2595 AM The Hague
Netherlands



Patents

Niobe
6,975,197; 7,019,610; 7,161,453; 7,305,263; 7,313,429; 7,495,537; 7,772,950;
7,966,059

Manufactured under the following European patent:
EP 1 488 431 issued in Germany, France, and the United Kingdom

Genesis RMN
7,774,046

Navigant
7,516,416; 7,537,570; 7,540,288; 7,540,866; 7,543,239; 7,627,361; 7,630,752;
7,657,075; 7,708,696; 7,751,867; 7,756,308; 7,761,133; 7,769,428; 7,831,294;
7,853,306; 8,024,024; 8,192,374; 8,369,934; 8,721,655; 9,314,222

Manufactured under the following European patents:

Document No.: HDW-0367
Revision: E, Effective Date: 5 May 2023

iCONNECT User Guide

EP 1 682 024 issued in Germany, France, and Great Britain; EP 1 769 390, issued in Germany, France, and the United Kingdom

Other patents issued and pending.

Trademarks

- *Cardiodrive*, *Navigant*, and *Niobe* are trademarks of Stereotaxis, Inc., registered in the United States, the European Community, the United Kingdom, and Japan.
- *Genesis RMN* is a trademark of Stereotaxis, Inc., registered in the United States.
- *Odyssey* is a trademark of Stereotaxis, Inc., registered in the United States, the European Community, and the United Kingdom.
- *Odyssey Cinema* is a trademark of Stereotaxis, Inc., registered in the European Community and the United Kingdom.
- *Odyssey Vision*, *Bullseye*, *NaviLine*, *NaviView*, *QuikCAS*, and *TargetNav*, are trademarks of Stereotaxis, Inc.

Other Trademarks

- *CARTO 3*, *SmartAblate*, *Navistar*, *Thermocool*, *Celsius*, and *Celsius Thermocool* are registered trademarks of Biosense Webster.
- *Rhythmia* and *Maestro 4000* are trademarks of Boston Scientific.
- *Ampere* and *EnSite Precision* are trademarks of St. Jude Medical.
- *HAT 500* is a registered trademark of Osypka.
- *AcQMap* is a registered trademark of Acutus Medical.

All other brand names, product names, or trademarks found in this document are the property of their respective owners.

EMC Directive Statement

EMC Directive Compliance	This equipment was tested and found to conform to the Medical Directive 93/42/EEC for electromagnetic compatibility. Compliance with this Directive is based upon compliance with the following harmonized standards:
Emissions:	IEC 60601-1-2 ed 4.0 (2014-02) CISPR11 ed 6.1 (2016-06), Class A (Professional Healthcare Facility Environment)
Immunity:	IEC 60601-1-2 ed 4.0 (2014-02), IEC 61000-4-2 ed 4.0 (2008-12), IEC 61000-4-3 ed 3.2 (2010-04), IEC 61000-4-4 ed 3.0 (2012-04), IEC 61000-4-5 ed 3.0 (2014-05) + AMD:2017, IEC 61000-4-6 ed 4.0 (2014 COR2015), IEC 61000-4-8 ed 2.0 (2009-09), IEC 61000-4-11 ed 2.0 (2004-03) + AMD1:2017

When operating this equipment, verify that other devices installed near it conform to the applicable EMC standards for that device. This equipment is designed to be installed and operated in a Professional Healthcare Facility Environment.

Safety Standard Statement

Safety Standard Compliance This equipment was tested and found to conform to the following IEC 60601-1 Medical Electrical Equipment General Requirements for basic safety and essential performance test specifications:

Standard: CAN/CSA-C22.2 No. 60601-1:14
ANSI/AAMI ES60601-1:2005+A2 (R2012) +A1
IEC 60601-1: 2005 + CORR. 1:2006 + CORR. 2:2007 + AM1:2012
(or IEC 60601-1: 2012 reprint)

Related documents

HDW-0312 Niobe ES User Guide
HDW-0358 Genesis RMN User Guide
HDW-0372 Navigant User Guide

Celsius Catheter Cable (001-009071-1) IFU
Magnoflush Catheter Cable (001-009073-1) IFU

CARTO System Cable (001-009075-1) IFU
Maestro System Cable (001-009077-1) IFU
Stockert System Cable (001-009078-1) IFU
Ampere System Cable (001-009079-1) IFU
HAT500 System Cable (001-009080-1) IFU
Navistar Adapter System Cable (001-009081-1) IFU

Consult the manufacturer's documentation for compatible devices and/or systems.

Operating conditions

Temperature: 15°C to 30°C
Humidity: 20% to 75%, non-condensing
Atmospheric pressure: 70 kPa to 106 kPa

Storage and transport conditions

Temperature: -10°C to 50°C
Relative humidity: 20% to 95%
Atmospheric pressure: 70 kPa to 106 kPa

Equipment information

iCONNECT Model no.: 001-009040-1
Classification: Class II Defibrillation-proof Type CF Applied Part equipment
Mode of operation: Continuous
Performance specifications:

Parameter	Specification
System Weight	1.0 kg
Maximum Power Draw	0.25 Amp @ 24 VDC

Document No.: HDW-0367
Revision: E, Effective Date: 5 May 2023

iCONNECT User Guide

Catheter Cable Model no.:

Celsius	001-009071-1
Magnoflush	001-009073-1

System Cable Model no.:

CARTO	001-009075-1
SmartAblate	001-009076-1
Maestro	001-009077-1
Stockert	001-009078-1
Ampere	001-009079-1
HAT500	001-009080-1
Navistar Adapter	001-009081-1
SmartAblate – EnSite	001-009091-1
HAT500 – EnSite	001-009092-1



WARNING: No modification of the *iCONNECT* System is allowed. No user-serviceable parts are inside *iCONNECT*. The user should not remove the cover or attempt to disassemble any portion of the *iCONNECT* System.

Notice to the User and/or Patient

Any serious incident that has occurred in relation to the device should be reported to the manufacturer and the competent authority of the Member State in which the user and/or patient is established.

Disposal

This product should be recycled and not disposed of as general waste (subject to WEEE annex IV resp. EN 50419).

Waste and Recycling

A contractor is responsible for the disposal and recycling of scrap metals and electronics found in the *iCONNECT* System.

Suggested Contractor: Walch Recycling & Eldelmentalle



Cover art

Cover art © 2020, 2023 Stereotaxis, Inc.

Contents

1	Overview	1
1.1	Introduction	1
1.2	About These Instructions	1
1.3	Indications.....	1
1.4	Contraindications.....	1
1.5	Clinical Benefits for Patients	1
1.6	Clinical Benefits for the Physician and Staff	1
1.7	Companion Systems	2
1.8	Required Training	2
1.9	Graphics and Symbols.....	2
1.10	Glossary.....	4
1.11	Safety Instructions	5
1.12	Electromagnetic Compatibility Information	7
2	Hardware.....	12
2.1	Electronics Hub.....	12
2.2	Connection Cables.....	12
2.3	Installation	13
3	Software.....	16
3.1	Magnetic Torque History	16
3.2	Impedance Graph	17
3.3	Hardware Status Panel Display	19
4	Maintenance	20
4.1	Cleaning	20
4.2	Sterilization of Cables.....	20
5	Troubleshooting.....	20

1 Overview

1.1 Introduction

iCONNECT™ is used in conjunction with a Stereotaxis Robotic Magnetic Navigation System (RMNS) and Navigant™ Workstation (NWS). The *iCONNECT* System provides an electronics hub allowing users to connect a combination of compatible catheters, mapping systems, and ablation generators. The *iCONNECT* System then gathers and provides catheter impedance values to *Navigant* where cardiac wall contact is determined.

For questions regarding the RMNS (Genesis RMN™ or Niobe™) or *Navigant*, refer to the applicable user guides listed in the Related Documents section above.

1.2 About These Instructions

The instructions provide information for installing, maintaining, and operating the *iCONNECT* System and for understanding the indicators on the equipment as well as through the *Navigant* software.

1.3 Indications

The *iCONNECT* System is an accessory device that indicates when the tip of a compatible catheter is in contact with the heart wall when used in conjunction with a compatible Magnetic Navigation System.

1.4 Contraindications

The *iCONNECT* System has no known contraindications.

1.5 Clinical Benefits for Patients

Fewer major and minor patient complications during RMNS ablation procedure. Reduction of harmful radiation to patients during RMNS ablation procedure due to shorter fluoroscopy times. Acute success, long-term success, and procedure times are similar between RMNS and manual procedures with no compromise to safety. Potential to treat more complex pathologies due to the precision, reach, and stability of the system.

1.6 Clinical Benefits for the Physician and Staff

Reduction of harmful radiation to clinical staff performing and/or participating in RMNS ablation procedure due to shorter fluoroscopy times, and system console location outside the x-ray exposure zone. Reduction in orthopedic burden to clinical staff because heavy lead aprons do not have to be worn for the duration of an RMNS ablation procedure as compared to manual ablation procedures for which the protective equipment is required. Reduction in posterior subcapsular changes (vision effects) from radiation.

1.7 Companion Systems

iCONNECT may be used with the following magnetically-compatible devices:

- NAVISTAR® RMT Catheter
- NAVISTAR® THERMOCOOL® RMT Catheter
- CELSIUS® RMT Catheter
- CELSIUS® THERMOCOOL® RMT Catheter
- MedFact MagnoFlush Catheter

iCONNECT may be used with the following ablation generators:

- Osypka HAT 500® Generator
- Ampere™ RF Generator
- Maestro 4000™ Cardiac Ablation System
- Biosense Webster Stockert 70 RF Generator
- Biosense Webster SmartAblate RF Generator

iCONNECT may be used with the following mapping systems:

- CARTO® 3
- Acutus AcQMap®

iCONNECT communicates with a Stereotaxis RMNS which integrates with a compatible, digital fluoroscopy system to provide real-time guidance to the physician during an interventional procedure.



1.8 Required Training

The Stereotaxis representative provides training and associated materials for safe and effective use of *iCONNECT* based on the intended use of the system. Training of *iCONNECT* features does not replace the physician's knowledge, expertise, or judgement.

1.9 Graphics and Symbols













The following graphics and symbols are used in these instructions:











WARNING		WARNING indicates a potentially hazardous situation which, if not avoided, could result in death or serious injury.
----------------	---	--

CAUTION		CAUTION indicates a potentially hazardous situation which, if not avoided, could result in injury to patient or operator or damage to the equipment.
Note		Note identifies information that could affect the outcome or results of the procedure.

Warnings and Cautions precede the text and any procedure involving a clear risk to the operator(s), the patient, or the equipment. Pay close attention to the instructions that accompany any warning, caution, and note symbols.

The following symbols are used in this document and/or on or near the system components:

Symbol Legend			
	Authorized Representative in the European Community		Catalogue Number
	Caution		Consult Instructions for Use
	Consulting the IFU is mandatory		Date of Manufacture
	Defibrillation-proof Type CF Applied Part		Do not use if package is damaged and consult instruction for use
	Keep Away from Sunlight		Keep Dry
	Importer		Lot Number

	Manufacturer		Marking for devices entering the European market
	Medical Device		Non-Sterile
	Packaging Unit		Prescription Only
	Product should be recycled and not disposed of as general waste		Serial Number
	Sterilized using Ethylene Oxide		Temperature Limit
	Usable Length		

1.10 Glossary





The following terms appear in this document:









Term	Description
C-Arm	X-ray image intensifier that produces live X-ray images displayed on a monitor and named because of its configuration, with the top part of the C extending over the patient and the bottom extending under.
iCONNECT Electronics Hub	Hardware portion of the system that allows users to connect a combination of catheters, mapping systems, and ablation generators.
iCONNECT System	Gathers and provides catheter impedance values to <i>Navigant</i> where contact with the heart wall is determined.
EP	Electrophysiology.
Fluoro	Fluoroscopic, or Fluoroscopy.

Term	Description
Fluoroscope	X-ray image intensifier that produces live X-ray images displayed on a monitor. Also called X-ray or C-Arm.
Robotic Magnetic Navigation (RMN) System	A medical platform that enables physicians to navigate catheters, guidewires and other magnetic interventional devices through the blood vessels and chambers of the heart to treatment sites and then to effect treatment; system consists of computer-controlled magnets that assist physicians in orienting and steering compatible, magnetically-adapted devices and works in conjunction with <i>Navigant</i> Workstation.
Impedance Graph	Feature of <i>Navigant</i> that displays bipolar impedance trend data to the user to aid in determining cardiac wall contact.
<i>Navigant</i> Workstation (NWS)	Platform of software applications designed to simplify clinical workflows. The <i>Navigant</i> product, when it does not include the <i>Odyssey</i> add-on, provides enhanced integration of catheterization and electrophysiology labs. In magnetic labs, <i>Navigant</i> also offers improved automation during magnetic navigation of medical devices.
Starburst	<i>Navigant</i> software feature of the <i>iCONNECT</i> System that indicates when the catheter tip is in contact with the heart wall.



1.11 Safety Instructions

1.11.1 Warnings

	WARNING: Federal law (USA) restricts this device to sale by or on the order of a physician.
	WARNING: The <i>iCONNECT</i> System should be used only by qualified medical professionals who have been thoroughly trained in its use.
	WARNING: Clinical decisions should not be based solely on impedance values. Additional sources of contact data should be used to confirm contact indication.
	WARNING: The user should not attempt to upgrade, configure, or run any other software programs on the RMNS computers other than those specified in the product documentation.



	WARNING: The graphical representation of the catheter on the RMNS display screen represents an approximate location and orientation of the catheter inside the patient's heart after the user acquires a new fluoro image and subsequently transfers it from the X-ray.
	WARNING: The operator should always confirm device location using a live fluoroscopic image.
	WARNING: Always verify catheter motion using live fluoroscopy images. Stop immediately if catheter motion can no longer be verified.
	WARNING: If unexpected catheter motion occurs during ablation, stop RF energy delivery.
	WARNING: If there is a cybersecurity breach during a procedure, press the E-stop button to stop all device activities. Contact the TeleRobotic Support Team to report the suspicious activity prior to resumption of the procedure.
	WARNING: Catheter cables shall be re-sterilized after use to avoid potential for patient infection.
	WARNING: Cables shall not be re-sterilized and used beyond indicated maximum as this could induce noise on ECG or mapping systems.
	WARNING: User shall not use devices for which packaging has been damaged.
	WARNING: Non-approved companion cable systems shall not be connected as this could result in damage to either product.

1.11.2 Precautions





	CAUTION: If a patient is to receive a permanent pacemaker or implantable cardiac defibrillator (ICD) <i>de novo</i> , the RMNS magnets must be kept in the Stowed position. The magnets should remain in the Stowed position from the moment the ICD/pacemaker is brought inside the Procedure Room until the patient is removed from the Procedure Room. Proper functioning of ICD/pacemaker should be verified following the removal of the patient from the Procedure Room.
	CAUTION: The points on the Mapping System screen are for reference only. Always confirm orientation of the catheter location with localization methods—fluoroscopy, for example—in addition to the electrograms.
	CAUTION: The points and catheter tip location displayed on the Mapping System screen can be transferred to the <i>Navigant</i> screen. The catheter tip displayed on the <i>Navigant</i> screen is used only as a visual reference to aid navigation, not to identify the location of the catheter tip in the heart.

	CAUTION: If the physician believes the catheter may be in the wrong location, the physician should refresh the fluoroscopy image. If a discrepancy occurs, the physician should reregister the mapping system to <i>Navigant</i> , remark the catheter base, and recalibrate the <i>Cardiodrive</i> System.
---	--

1.11.3 Notes

-  Always verify the fluoroscopy images match the current patient.
-  Before ablation, verify the field is applied to ensure proper device functionality.

1.12 Electromagnetic Compatibility Information

	WARNING: The use of accessories, transducers, and cables other than those specified, with the exception of transducers and cables sold by Stereotaxis, Inc., may result in increased emissions or decreased immunity of the equipment.
	WARNING: The equipment should not be used adjacent to or stacked with other equipment. If adjacent or stacked use is necessary, the equipment should be observed to verify normal operation in the configuration in which it will be used.
	WARNING: This equipment has been tested for radiated radiofrequency (RF) immunity only at selected frequencies, and use of nearby emitters at other frequencies could result in improper operation. Improper operation may consist of (1) prevention of patient treatment, (2) uncontrolled motion of magnets, and (3) uncontrolled motion of the <i>Cardiodrive</i> System.
	Note: In addition to the requirements of 7.9.3 of the general standard for Permanently Installed Large Medical Electrical (ME) Equipment and Large ME Systems for which the exemption specified in 8.6 from the testing requirements of IEC 61000-4-3 is used, this technical description includes the following information:

Following are the frequencies and modulations used to test the Immunity of the ME Equipment or ME System:

- 52.5Mhz
- 144Mhz
- 433Mhz
- 448Mhz
- 452Mhz
- 467Mhz
- 470Mhz
- 1.2Ghz
- 2.4Ghz
- 5.0Ghz

1.12.1 Emissions

The equipment is intended for use in the electromagnetic environment specified in the following tables. The user of the equipment should ensure it is used in such an environment. The following table provides guidance and Stereotaxis' declaration on **electromagnetic emissions** for the equipment:

Emissions	Compliance	Electromagnetic environment—guidance
RF emissions CISPR 11	Group 1	The equipment uses RF energy only for its internal function. Therefore, its RF emissions are very low and are not likely to cause any interference in nearby electronic equipment.
RF emissions CISPR 11	Class A Complies	
Harmonic emissions IEC 61000-3-2		
Voltage fluctuations/ flicker emissions IEC 61000-3-3		



WARNING: The EMISSIONS characteristics of this equipment make it suitable for use in industrial and hospital (CISPR 11 class A) settings. If it is used in a residential environment (for which CISPR 11 class B is normally required), this equipment might not offer adequate protection to radio-frequency communication services. The user might need to take mitigation measures, such as relocating or re-orienting the equipment.

1.12.2 Immunity—General electromagnetic effects

The following table provides guidance and Stereotaxis' declaration on **electromagnetic immunity** regarding general electromagnetic effects for the equipment:

Immunity test	IEC 60601 test level*	Compliance level*	Electromagnetic environment—guidance
Electrostatic discharge (ESD) IEC 61000-4-2	± 8 kV contact ± 2, 4, 8 & 15 kV air	± 8 kV contact ± 2, 4, 8 & 15 kV air	Floors should be wood, concrete, or ceramic tile. If floors are covered with synthetic material, the relative humidity should be at least 30%.
Electrical fast transient/burst IEC 61000-4-4	± 2 kV for power supply lines ± 1 kV for input/output lines	± 2 kV for power supply lines ± 1 kV for input/output lines	Mains power quality should be that of a typical commercial or hospital environment.

Immunity test	IEC 60601 test level*	Compliance level*	Electromagnetic environment—guidance
Surge IEC 61000-4-5	± 1 kV line(s) to line(s) ± 2 kV line(s) to earth	± 1 kV line(s) to line(s) ± 2 kV line(s) to earth	Mains power quality should be that of a typical commercial or hospital environment.
Voltage dips, short interruptions and voltage variations on power supply input lines IEC 61000-4-11	<5 % U_T (100 % dip in U_T) for 0.5 cycle 40 % U_T (60 % dip in U_T) for 5 cycles 70 % U_T (30 % dip in U_T) for 25 cycles <5 % U_T (>95 % dip in U_T) for 5 s	<5 % U_T (100 % dip in U_T) for 0.5 cycle 40 % U_T (60 % dip in U_T) for 5 cycles 70 % U_T (30 % dip in U_T) for 25 cycles <5 % U_T (>95 % dip in U_T) for 5 s	Mains power quality should be that of a typical commercial or hospital environment. If the user of the equipment requires continued operation during power mains interruptions, it is recommended that the equipment be powered from an uninterruptible power supply or a battery.
Power frequency (50/60 Hz) magnetic field IEC 61000-4-8	30 A/m	30 A/m	Power frequency magnetic fields should be at levels characteristic of a typical location in a typical commercial or hospital environment.

* U_T is the a.c. mains voltage before application of the test level.

1.12.3 Immunity—RF interference

The following table provides guidance and Stereotaxis' declaration on **electromagnetic immunity** regarding radiofrequency (RF) for the equipment:

Immunity test	IEC 60601 test level	Compliance level	Electromagnetic environment—guidance
Conducted RF IEC 61000-4-6	3 Vrms	3 V	Portable and mobile RF communications equipment should be used no closer to any part of the equipment, including cables, than the recommended separation distance calculated from the equation applicable to the frequency of the transmitter.
Radiated RF IEC 61000-4-3	150 kHz to 80 MHz 3 V/m 80 mHz to 2.7 GHz	3 V/m	

Immunity test	IEC 60601 test level	Compliance level	Electromagnetic environment—guidance
Proximity Fields to RF Wireless Communications	27V/m		Recommended separation distance
	380-390Mhz		$d = 1.2\sqrt{P}$ $d = 1.2\sqrt{P}$ 80 MHz to 800 MHz $d = 2.3\sqrt{P}$ 800 MHz to 2.5 GHz
	28V/m	27V/m	where P is the maximum output power rating of the transmitter in watts (W) according to the transmitter manufacturer and d is the recommended separation distance in meters (m).
	430-470Mhz	28V/m	Field strengths from fixed RF transmitters, as determined by an electromagnetic site survey, ^a should be less than the compliance level in each frequency range. ^b
	800-960Mhz	28V/m	Interference may occur in the vicinity of equipment marked with the following symbol:
	1700-1990Mhz		
	2400-2570Mhz	9V/m	
	9V/m		
	704-787Mhz		
	5100-5800Mhz		

Note 1: At 80 MHz and 800 MHz, the higher frequency range applies.

Note 2: These guidelines may not apply in all situations. Electromagnetic propagation is affected by absorption and reflection from structures, objects, and people.

a Field strengths from fixed transmitters, such as base stations for radio (cellular/cordless) telephones and land mobile radios, amateur radio, AM and FM radio broadcast, and TV broadcast cannot be predicted theoretically with accuracy. To assess the electromagnetic environment due to fixed RF transmitters, an electromagnetic site survey should be considered. If the measured field strength in the location in which the equipment is used exceeds the applicable RF compliance level above, the equipment should be observed to verify normal operation. If abnormal performance is observed, additional measures may be necessary, such as re-orienting or relocating the equipment or needing to contact the TeleRobotic Support Team.

b Over the frequency range 150 kHz to 80 MHz, field strengths should be less than 3 V/m.

1.12.4 Separation distances

The equipment is intended for use in the electromagnetic environment in which radiated RF disturbances are controlled. The user can help prevent electromagnetic interference by

maintaining a minimum distance between portable and mobile RF communications equipment (transmitters) and the equipment as recommended in the following table, according to the maximum output power of the communications equipment.

The table provides **recommended separation distances** between portable and mobile RF communications equipment and the affected equipment.

Rated maximum output power of transmitter* W	Separation distance according to frequency of transmitter m		
	150 kHz to 80 MHz $d = 1.2\sqrt{P}$	80 MHz to 800 MHz $d = 1.2\sqrt{P}$	800 MHz to 2.5 GHz $d = 2.3\sqrt{P}$
0.01	0.12	0.12	0.23
0.1	0.38	0.38	0.73
1	1.2	1.2	2.3
10	3.8	3.8	7.3
100	12	12	23

* For transmitters rated at a maximum output power not listed above, the recommended separation distance d in meters (m) can be estimated using the equation applicable to the frequency of the transmitter, where P is the maximum output power rating of the transmitter in watts (W) according to the transmitter manufacturer.

Note 1: At 80 MHz and 800 MHz, the separation distance for the higher frequency range applies.

Note 2: These guidelines may not apply in all situations. Electromagnetic propagation is affected by absorption and reflection from structures, objects, and people.



WARNING: Portable RF communications equipment (including peripherals such as antenna cables and external antennas) should be used no closer than 30 cm (12 inches) to any part of the equipment, including cables specified by Stereotaxis, Inc.



Note: If there are Electromagnetic Compatibility (EMC) issues with the equipment, please contact Stereotaxis TeleRobotic Support Team. Otherwise, there are no specific service requirements to maintain EMC integrity.

2 Hardware

The *iCONNECT* System gathers impedance values in relation to electrode connections. The unaltered values are then sent through the *iCONNECT* Electronics Hub to *Navigant* where impedance is measured, and contact is determined.

Prior to each use of the *iCONNECT* System, preventive inspection of the Electronics Hub and all connection cables shall be performed. If any cable damage is observed, discard the cable and do not use or reuse. If any damage is observed of the *iCONNECT* System, contact the Stereotaxis TeleRobotic Support Team (TST) at 1-866-269-5268 or 1-314-678-6200 or email at tst@stereotaxis.com

2.1 Electronics Hub

The *iCONNECT* Electronics Hub (**Figure 1**) has connection points for catheter cables and mapping system/ablation generators. The red port is for the catheter cable and the blue port is for the mapping system or ablation generator cable.

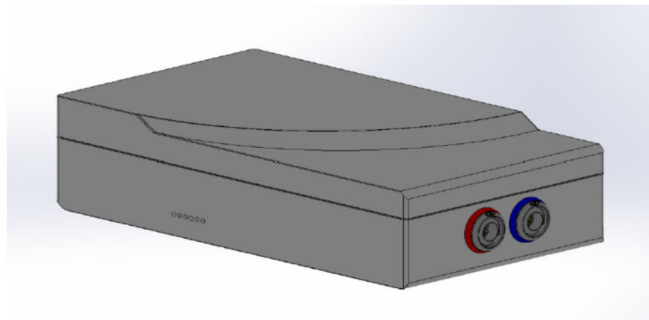

Figure 1. iCONNECT Electronics Hub

2.2 Connection Cables

The *iCONNECT* System offers use of two sets of connection cables (**Figure 2**), one for the connection between *iCONNECT* and the catheter (*Catheter Cables*) and one for connection between *iCONNECT* and the mapping and/or ablation system (*System Cables*). Catheter cables are provided sterile, with the ability to be resterilized. See **Table 1** and **Table 2** for a list of cables and possible connections.

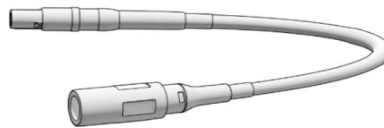

Figure 2. Connection Cable

Table 1. Catheter Cables (Sterile)

Connection	Catalogue Number
iCONNECT – Celsius	001-009071-1
iCONNECT – Magnoflush	001-009073-1

Table 2. System Cables (Non-sterile)

Connection	Catalogue Number
iCONNECT – CARTO	001-009075-1
iCONNECT – SmartAblate	001-009076-1
iCONNECT – Maestro	001-009077-1
iCONNECT – Stockert	001-009078-1
iCONNECT – Ampere	001-009079-1
iCONNECT – HAT500	001-009080-1
iCONNECT – Navistar Adapter	001-009081-1
iCONNECT – SmartAblate – EnSite	001-009091-1
iCONNECT – HAT500 – EnSite	001-009092-1

2.3 Installation

Below are instructions for connecting the *iCONNECT* Electronics Hub (**Figure 3**) to the catheter, mapping system, and/or ablation generator. Refer to **Figure 3** and **Figure 4** while following the steps.

Installing the *iCONNECT* System is a joint venture between the user and Stereotaxis. **Step 1** must be performed by a Stereotaxis Field Service representative. All subsequent steps can be carried out by the user.



Note: For emphasis, the LEDs are outlined in Figure 3.

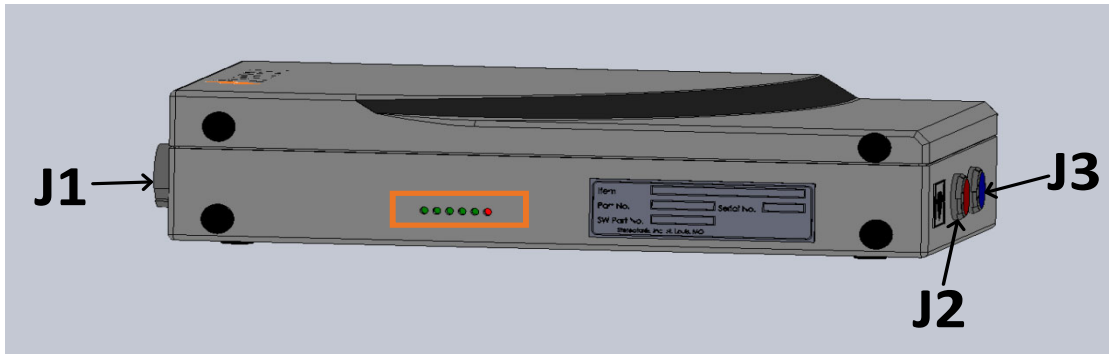

Figure 3. iCONNECT Electronics Hub — connector and LED location identifiers

1. The Stereotaxis Field Service representative connects the Ethernet cable (P/N 072-011422-1) from A15-J22 of the RMNS cabinet to **J1** of the electronics hub. The Ethernet cable provides power and communication for the *iCONNECT* System.
2. To connect the catheter cable, insert the connector of the catheter cable in the red **J2** socket of the electronics hub and in the ablation catheter in accordance with the information on the cable plugs.
3. If using a Navistar Adapter Cable, insert the connector of the cable in the red **J2** socket of the electronics hub. The opposite end connects to the Biosense Webster Interface Cable **C5MHNAVMHS**. The free, unconnected end of the Interface Cable connects to the NAVISTAR® RMT Catheter or NAVISTAR® THERMOCOOL® RMT Catheter.
 - a. It is important to note that if a Navistar Adapter Cable is used, an Interface Cable is needed and must be ordered through Biosense Webster.
4. To connect the system cable, insert the connector of the system cable in the blue **J3** socket of the electronics hub and in the RF ablation device or the external connection box for the mapping system.
5. Verify the LEDs are correct according to **Table 3**.

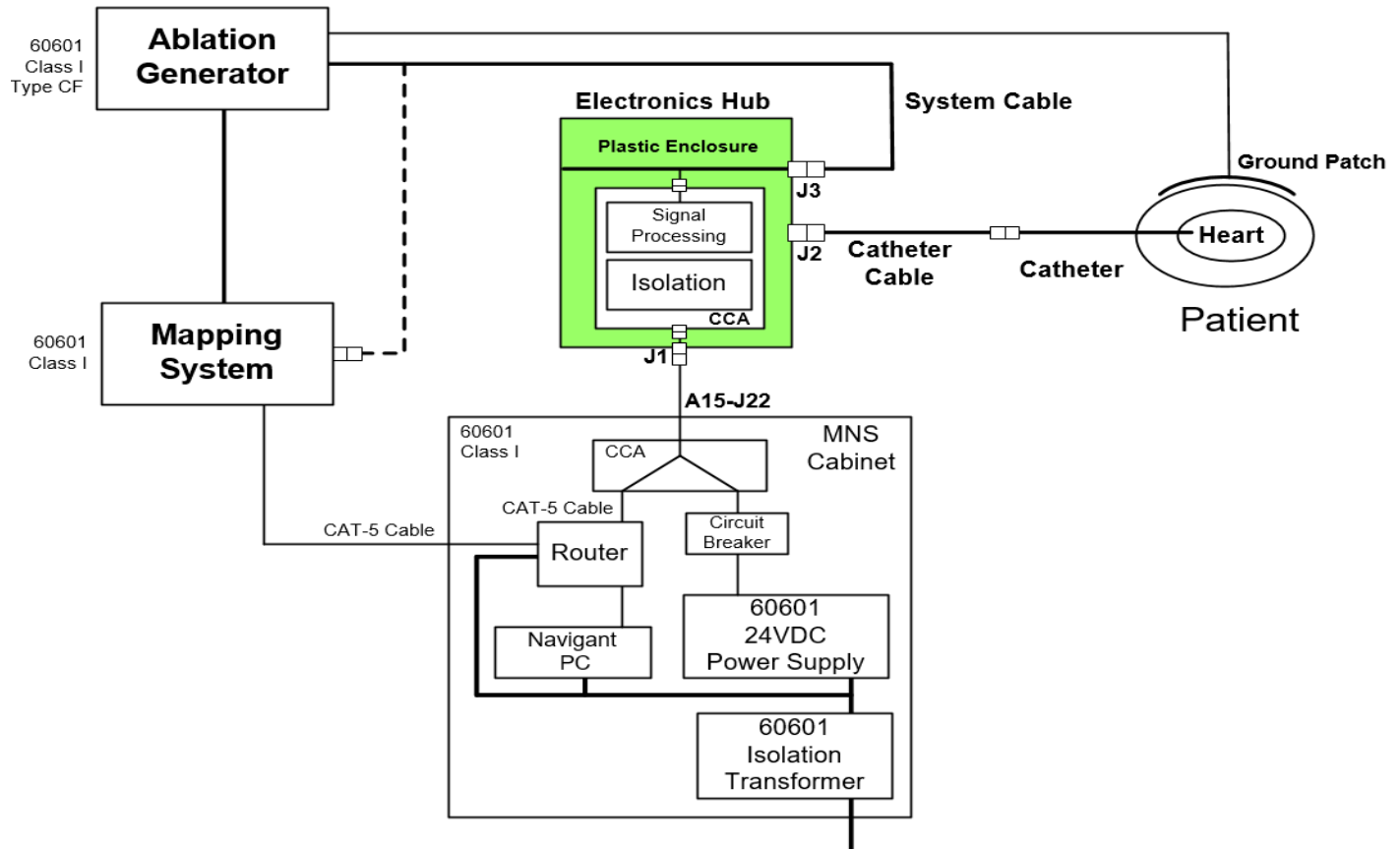

Figure 4. iCONNECT System Hardware Connectivity



Note: Consult the applicable User Guide for questions regarding compatible devices and/or systems.



CAUTION: Protection of the device and patient is dependent upon the use of appropriate cables. Follow all instructions carefully and contact Stereotaxis TeleRobotic Support Team with any questions regarding cable use or installation.

After completing all connections (Figure 4), the external LEDs (Figure 5) on the *iCONNECT* Electronics Hub box should light as indicated in Table 3. When the indicators are lit as shown below, the *iCONNECT* System is on and ready for use.



Figure 5. iCONNECT System LEDs (example)

Table 3. iCONNECT System LED indicators

LED	Action
1	Red LED: If lit, indicates error.
2	Starts blinking after a few seconds, indicates processor is active.
3	Final green LED to light, indicates network connectivity to <i>Navigant</i> System.
4	Should light when iCONNECT Ethernet cable is connected.
5	Should light when iCONNECT Ethernet cable is connected.
6	Should light when iCONNECT Ethernet cable is connected.

3 Software

The *iCONNECT* System communicates with *Navigant* which indicates the level of tip-to-tissue contact and the hardware status of *iCONNECT*. The Magnetic Torque History and the Impedance Graph, described in the following sections, may only be utilized and enabled / disabled within *Navigant*.

3.1 Magnetic Torque History

The *Navigant* screen displays a Magnetic Torque History at the bottom of the window to provide a color-coded History indicating cardiac wall contact. The dots are gated positions / timestamps (**Figure 6**). The History is:

- blue during Optimal Contact
- dashed during In Contact
- gray during No Contact

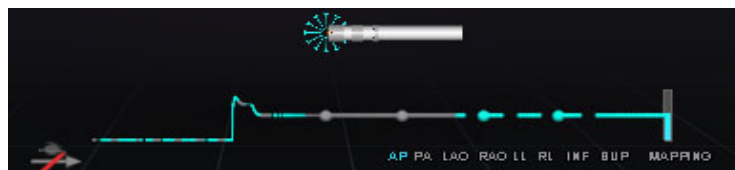

Figure 6. Magnetic Torque History and “starburst” — iCONNECT connected

When *iCONNECT* is present and on, and the catheter is in contact with the cardiac wall, the *Navigant* screen displays a “starburst.” The starburst has three states:

- Optimal Contact (**Figure 7, left**)
- In Contact (**Figure 7, right**)
- No Contact: No starburst

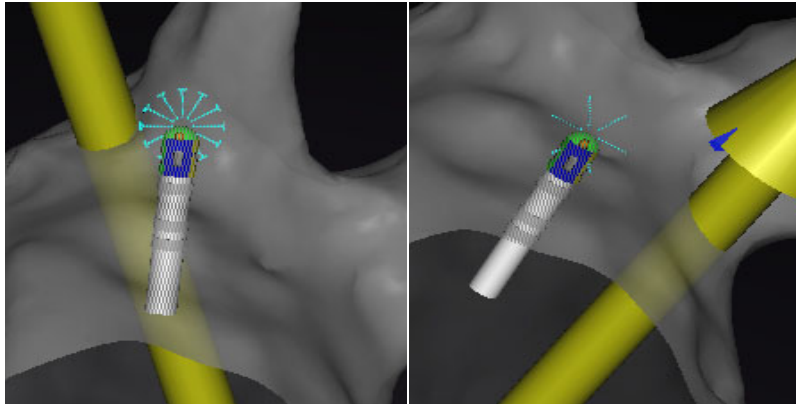

Figure 7. Starburst states: Optimal Contact (left); In Contact (right)

When *iCONNECT* is not connected, the Magnetic Torque History is purple (**Figure 8**). A starburst is not present as *Navigant* is not measuring the level of contact.

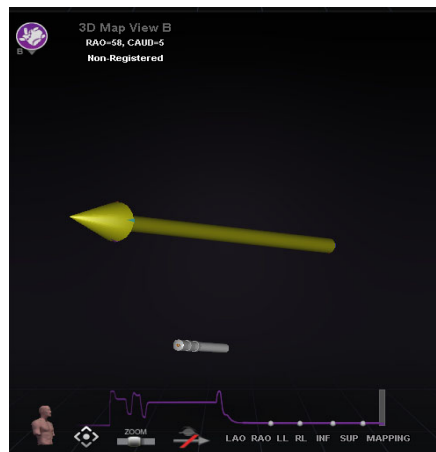

Figure 8. Magnetic Torque History — iCONNECT disconnected

3.2 Impedance Graph

The Impedance Graph can be selected within a *Navigant* window. To obtain data, ensure the *iCONNECT* System is connected and enabled, and a compatible catheter is positioned in the heart.

The Impedance Graph overlay displays two traces (**Figure 9**). **Channel 1** trace (*yellow*) is the impedance between electrode 1 and electrode 3. **Channel 2** trace (*blue*) is the impedance between electrode 2 and 4. Real-time impedance readings are darker and noisier, and result in bigger waves. Moving averages are brighter and smoother, and result in smaller waves.

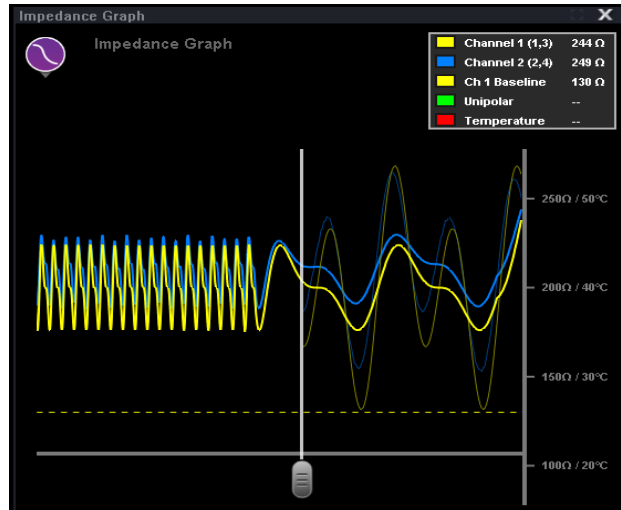

Figure 9. Impedance Graph

A labels box (**Figure 10**) is present in the upper right-hand corner of the window. Any trace color can be changed by clicking the corresponding colored square and selecting the desired color from the palette. Unipolar impedance and ablation temperature values are provided during energy delivery. Unipolar impedance, measured by the RF generator, is the impedance from the catheter tip to the ground patch on the patient's skin. The baseline represents the impedance value when the catheter tip is in the blood pool.



Figure 10. Labels box

The maximum duration of the impedance graph is ~100 seconds. The right side of the graph reflects impedance in real time at the tip of the catheter, whereas the left side represents impedance history. A sliding bar is present so the user can adjust time along the x-axis to see more history or real-time data (**Figure 11**).

Real-time impedance values only exist to the right of the sliding bar. Baseline impedance, unipolar impedance, ablation temperature, and average impedance data extend the entire length of the impedance graph. The red line on the bottom of the graph indicates that ablation is occurring. When gray, ablation is not occurring.

The user can click and drag anywhere on the graph to move it up and down. The user can also click and drag on the y-axis (displaying impedance and temperature) to zoom in or out. The scale auto adjusts, and the number of tick marks change accordingly. If the user double clicks the y-axis scale, the scale resets to the initial values present at the start of a new procedure.

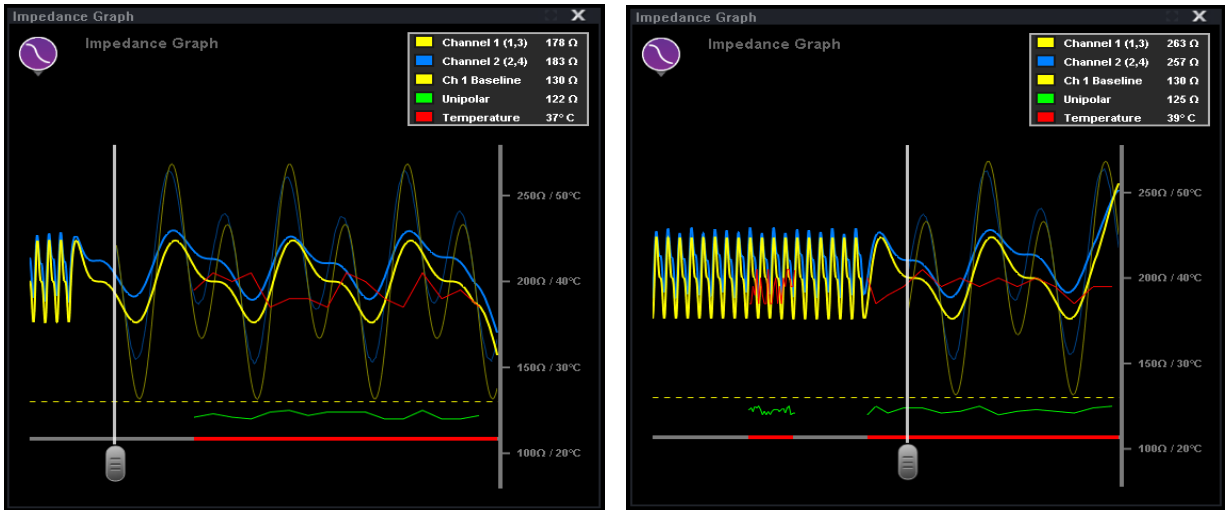

Figure 11. Sliding bar adjustment

3.3 Hardware Status Panel Display

The *Navigant* hardware status indicator bar shows an additional icon when the *iCONNECT* System feature is present (Figure 12). As shown in Figure 13, the *iCONNECT* System icon has three possible statuses.

Table 4 lists examples of the **Warning** and **Error** *iCONNECT* System states and the possible or reported reasons.

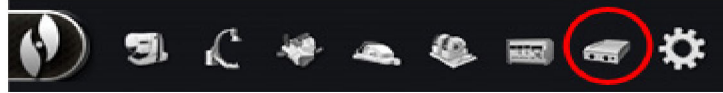

Figure 12. iCONNECT System icon



Figure 13. iCONNECT System status icons

Table 4. iCONNECT System states

State	Reason
Warning	Contact data is out of range (alert is cleared when contact data returns to correct range)
Error	<i>Navigant</i> System not connected to <i>iCONNECT</i> (alert is revoked when <i>Navigant</i> System connects to <i>iCONNECT</i>)
Error	<i>iCONNECT</i> reporting error (alert is revoked when device reports that error has been cleared)

4 Maintenance

4.1 Cleaning

Do not autoclave or submerge the *iCONNECT* Electronics Hub. The *iCONNECT* Electronics Hub and cables are designed to be wiped down with a cloth or swab dampened in pH neutral, EPA-approved hospital grade solutions.

Discard all cleaning materials in accordance with all local, state, and federal regulations, codes, and directives.

4.2 Sterilization of Cables

The *iCONNECT* Catheter Cables are supplied sterile. Refer to the respective catheter cable IFU for more information regarding sterility and resterilization methods of the cables.

5 Troubleshooting

If assistance is needed with any of the solutions below, call the TeleRobotic Support Team (TST) at 1-314-678-6200 or 1-866-269-5268.

Problem		Solution
iCONNECT System unit LED indicator errors (see Figure 5 for LED locations)	> 0 and < 3 leftmost LEDs are lit.	Call the TST for Field Service evaluation.
	All 3 leftmost LEDs are on, and LED 3 is <i>not</i> blinking.	Call the TST for Field Service evaluation.

Problem		Solution
	All 3 leftmost LEDs are on, and LED 3 is blinking, but LED 4 is not lit.	Further investigation is required. Call the TST.
	Red LED is lit.	An error has occurred. Unplug the Ethernet cable and plug it back in. If the problem persists, call the TST.
iCONNECT warning and errors (in relation to the Navigant System)	<i>iCONNECT</i> unit reports contact data that is out of range. <i>Navigant System</i> indicates a persistent warning alert by way of the <i>iCONNECT</i> System status icon.	Check the catheter connections. If the warning alert fails to clear, call the TST.
	<i>iCONNECT</i> unit reports board error. <i>Navigant System</i> indicates a persistent error alert by way of the <i>iCONNECT</i> status icon.	The alert is revoked when the unit reports the error has been cleared. If the unit fails to revoke the error, call the TST.
	<i>Navigant System</i> is not connected to <i>iCONNECT</i> . <i>Navigant System</i> indicates a persistent error alert by way of the <i>iCONNECT</i> status icon.	Connect the <i>Navigant System</i> to <i>iCONNECT</i> . The alert should clear, but if the alert fails to clear, call the TST.

Refer to the change control in the quality management system for the electronic signatures.

Date of Last Signature:25-May-2023 20:31 (GMT)